

Control block VOFA with safety function

FESTO

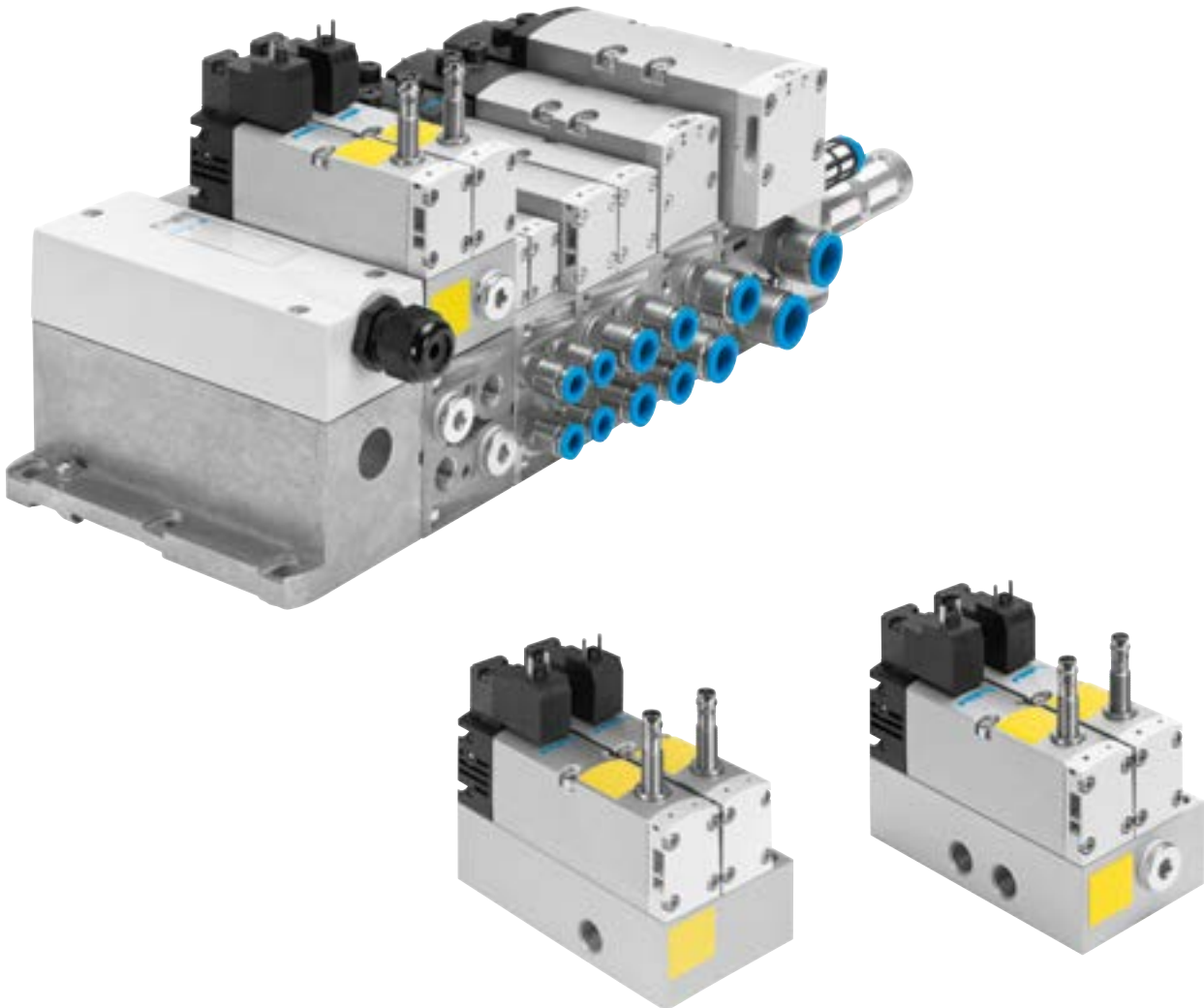

Key features



Innovative

- Can be used for safe reversing of a hazardous movement (5/2-way solenoid valve)
- Can be used for safe exhausting (3/2-way solenoid valve function, not available as a variant for installation on a valve terminal)
- Purely mechanical solution as a press safety valve, without integrated diagnostics

Versatile

- Control block can be selected as a version for valve terminal VTSA/VTSA-F
- Control block can be selected as individual pneumatic connection
- High pressure range, 3 ... 10 bar
- Flow rates of up to 1050 l/min

Reliable

- Sturdy and durable metal components
- Designed as a purely mechanical solution with regard to safety

Easy to mount

- Ready-to-install and tested unit
- Reduced outlay on selection, ordering, assembly and commissioning
- Mounting via through-hole (with individual pneumatic connection)
- Mounting as vertical stacking elements on manifold sub-base of the valve terminal

Note

The control block with safety function VOFA must not be modified by the customer without authorisation as this invalidates the IFA approval certificate. The IFA certificate is linked to the certified safety function of the component.

Key features

Description

The control block is designed for two-channel control of pneumatic drive components such as double-acting cylinders, and can be used to realise the following protective measures:

- Protection against unexpected start-up (EN 1037)
- Reversing hazardous movements, provided the reversing movement will not lead to any further hazards (5/2-way single solenoid valve)
- Safe exhausting (with function as 3/2-way solenoid valve, normally closed)

The control attributes of the control block enable Performance Level e (up to category 4, corresponds to the highest risk level) to be achieved for the protective measures. The Performance Level (PL) is a measure of the reliability of a safety function.

The control block has been developed and manufactured in accordance with the basic and proven safety principles of EN ISO 13849-1 and EN ISO 13849-2.

The requirements of EN ISO 13849-1 and EN ISO 13849-2 (e.g. CCF, DC) must be taken into consideration for the implementation and operation of the component, and for use in higher categories (2 to 4).

When using this product in machines or systems subject to specific C standards, the requirements specified in these standards must be observed.

The control block with safety function is designed for installation in machines and automation systems and must only be used in industrial applications (high-demand mode)! The control block with safety function is suitable for use as a press safety valve to EN 692.

Further information and technical data in the Support Portal

→ Internet: safety engineering guidelines

Pneumatic/electrical interlinking Function

The safety function is achieved through two-channel pneumatic linking of two single solenoid 5/2-way valves, width 26 mm, within the control block:

- Port 4 is only pressurised if both solenoid valves are in switching position.
- Port 2 is always pressurised if at least one of the two solenoid valves is in normal position. The valves are reset via a mechanical spring.

The switching operation of the solenoid valves can be monitored by sensing using the proximity switch at the solenoid valves (switching position sensing).

By connecting the control signal and the switching signal of the proximity switch it is possible to check if the piston spools of the solenoid valves have reached or left the normal position (expectations).

The piston spools of the solenoid valves are designed so that pneumatic short circuits between ports 2 and 4 are prevented (positive overlap).

The two solenoid valves must be actuated via two separate channels to achieve the desired category 4 (Performance Level e, to EN ISO 13849-1).

The valves used are always 5/2-way solenoid valves with switching position sensing.

Key features

Design

Decentralised individual connection variant, VOFA-L26-T52-...

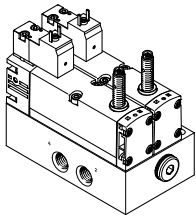

With the decentralised individual connection variant, the electrical connection for the control block is established as an individual connection to ISO 15407-1. The pneumatic connection is also established as an individual connection. With this variant, the two 5/2-way solenoid valves are pneumatically linked using the individual sub-base via two channels.

The electrical connection for the solenoid valves is established separately via a standardised square plug to EN 175301-803, type C.

The electrical connection for the inductive sensor for switching position sensing is established via a push-in connector M8x1 to EN 61076-2-104.

Decentralised individual connection variant, VOFA-L26-T32C-...

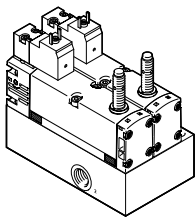

The function as a 3/2-way solenoid valve, normally closed, is intended for use for safe exhausting.

- - Note

The function as 3/2-way solenoid valve is only available as a decentralised individual connection variant (VOFA-L26-...).

Version for valve terminal VTSA/VTSA-F, VOFA-B26-T52-...

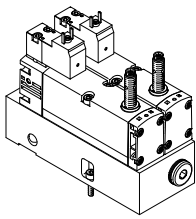

With the version of the control block for valve terminal VTSA/VTSA-F, the valves are actuated separately from the valve terminal via an individual electrical connection. The pneumatic connection is established via the valve terminal VTSA/VTSA-F.

With the variant for valve terminals, the two 5/2-way solenoid valves are pneumatically linked using an intermediate plate (vertical stacking element) via two channels.

The electrical connection for the solenoid valves is established separately

via a standardised square plug to EN 175301-803, type C.

The electrical connection for the inductive sensor for switching position sensing is established via a push-in connector M8x1 to EN 61076-2-104.

- - Note

The appropriate manifold sub-base VABV-S4- ..., which is required for integration into the valve terminal, is not part of the control block. It is automatically allocated by the configurator when the control block is selected.

Key features

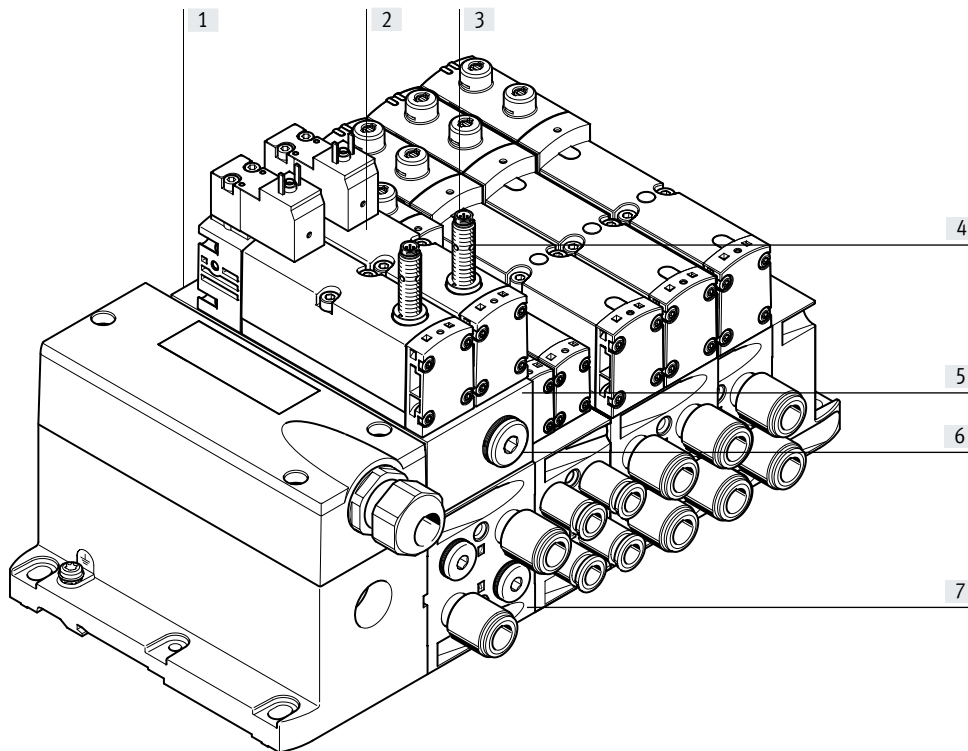

- [1] Control block VOFA integrated in valve terminal VTSA/VTSA-F
- [2] Two 5/2-way solenoid valves, pneumatically linked with sensing function
- [3] Inductive NPN or PNP sensor with M8 interface
- [4] Yellow status indication LED
- [5] Intermediate plate as pneumatic vertical stacking element
- [6] Optional connection for pressure gauge (at port 2)
- [7] Manifold sub-base for valve terminal VTSA/VTSA-F

Equipment options

Control block as a version for valve terminal VTSA/VTSA-F, VOFA-B26-T52-...

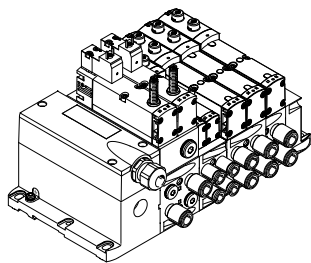

- Two 5/2-way single solenoid valves, connected in series, linked via two channels
- Mechanical spring
 - Switching position sensing via inductive sensors with PNP or NPN output

Application:

- Protection against unexpected start-up to EN 1037
- Safe reversing
- Drives in manually loaded devices

 **Note**

The function as 3/2-way solenoid valve is not suitable for vertical stacking (on valve terminals).

Control block as decentralised individual connection variant

VOFA-L26-T52-...

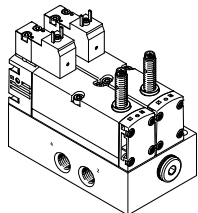

- Two 5/2-way single solenoid valves, connected in series, linked via two channels
- Mechanical spring
 - Switching position sensing via inductive sensors with PNP or NPN output

Application:

- Protection against unexpected start-up to EN 1037
- Safe reversing (VOFA-L26-T52-...)
- Safe exhausting (VOFA-L26-T32C-..., function as 3/2-way solenoid valve)
- Drives in manually loaded devices

 **Note**

The control block with safety function VOFA must not be modified by the customer without authorisation as this invalidates the IFA approval certificate.

The IFA certificate is linked to the certified safety function of the component.

VOFA-L26-T32C-...

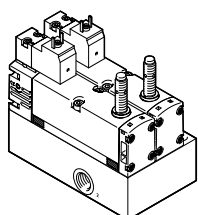

Key features

Special features

Control block for valve terminal VTSA/VTSA-F

Control block as decentralised individual connection variant

Electrical connection

- Electrical connection to EN 175301-803 type C (square plug)
- 3-pin sensor push-in connector M8

Pneumatic connection

- Via valve terminal VTSA/VTSA-F
- Pilot air supply via valve terminal
- Linked using the intermediate plate (vertical stacking) via two channels

Electrical connection

- Electrical connection to EN 175301-803 type C (square plug)
- 3-pin sensor push-in connector M8

Pneumatic connection

- Individual pneumatic connection
- Internal pilot air supply
- Linked using an individual sub-base via two channels

Applications

This control block is suitable for use as a press safety valve to EN 692.

This valve is a safety device in accordance with the Machinery Directive 2006/42/EC.

The 3/2-way solenoid valve version (VOFA-L26-T32C-...) is intended for safe exhausting.

The version for valve terminals VTSA/VTSA-F and the version as individual connection variant VOFA-L26-T52-... are intended for safe reversing of a hazardous movement.

Valve terminal configurator

→ Internet: www.festo.com

A valve terminal configurator is available to help you select a suitable VTSA/VTSA-F valve terminal.

The control block VOFA for the valve terminal is ordered using this valve terminal configurator, making it much easier to order the right product.

The valve terminals are fully assembled according to your order specification and are individually checked. This reduces assembly and installation time to a minimum.

Order a control block VOFA for the valve terminal VTSA using the order code:

Ordering system for VTSA

→ Internet: vtsa

Order a control block VOFA for the valve terminal VTSA-F using the order code:

Ordering system for VTSA-F

→ Internet: vtsa-f

Key features

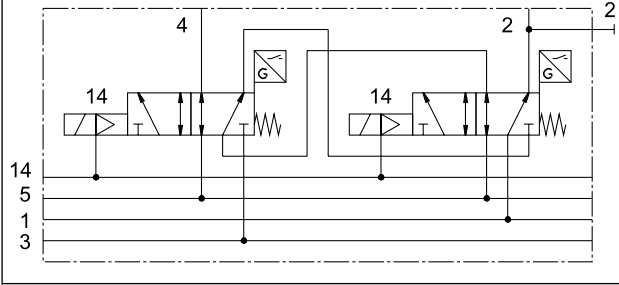
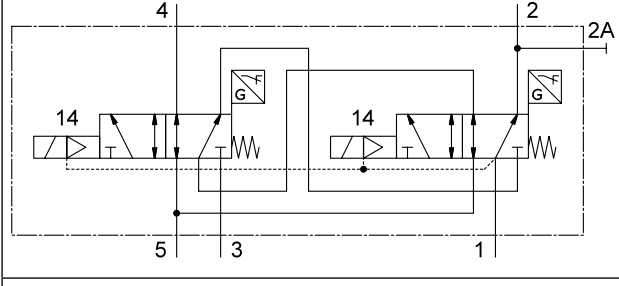
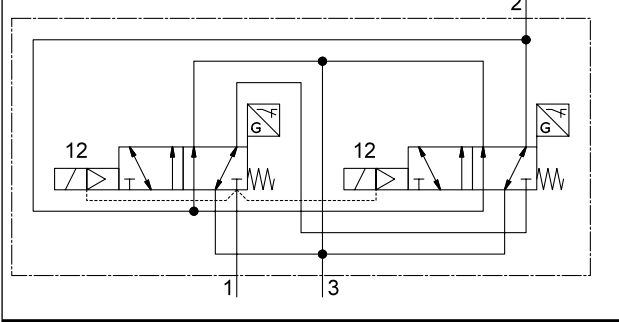
Valve function Circuit symbol ¹⁾	Description
	<p>Control block VOFA-B26-T52-...</p> <p>As a version for valve terminal VTSA/VTSA-F with 2x 5/2-way single solenoid valve</p> <ul style="list-style-type: none"> • Pneumatic connection via valve terminal • Mechanical spring return • With NPN sensor (code SN) or PNP sensor (code SP) • Fulfils the safety function <ul style="list-style-type: none"> – Safe reversing – Protection against unexpected start-up (EN 1037)
	<p>Control block VOFA-L26-T52-...</p> <p>As decentralised individual connection variant with 2x 5/2-way single solenoid valve</p> <ul style="list-style-type: none"> • As individual pneumatic connection • Mechanical spring return • With NPN or PNP sensor • Fulfils the safety function <ul style="list-style-type: none"> – Safe reversing – Protection against unexpected start-up (EN 1037)
	<p>Control block VOFA-L26-T32C-...</p> <p>As decentralised individual connection variant with 3/2-way solenoid valve function, normally closed (the two valves are pneumatically linked using the individual sub-base)</p> <ul style="list-style-type: none"> • As individual pneumatic connection • Mechanical spring return • With NPN or PNP sensor • Fulfils the safety function <ul style="list-style-type: none"> – Safe exhausting – Protection against unexpected start-up (EN 1037)

1) The symbol represents a valve with a proximity switch with a switching output signal, in the illustration an N/O contact. In accordance with ISO 1219-1, this symbol applies to both N/O contacts and N/C contacts. The switching element function of all sensors used here is an N/C contact.

 **Note**

- The 2x 5/2-way solenoid valves each have their own electrical connection.
- The 2x 5/2-way solenoid valves are pneumatically linked using an individual sub-base/intermediate plate via two channels.
- The output of the linked 2x 5/2-way solenoid valves is only switched if both valves are in switching position.

Data sheet

Safety characteristics			
Control block	VOFA-L26-T52-...	VOFA-L26-T32C-...	VOFA-B26-T52-... on valve terminal
Conforms to standard	EN 13849-1		
Safety function	Protection against manipulation, protection against unexpected start-up		
	Reversing a movement	Exhausting	Reversing a movement
Performance Level (PL)	Protection against manipulation, protection against unexpected start-up/up to category 4, Performance Level e)		
	Reversing a movement/up to category 4, Performance Level e	Exhausting/up to category 4, Performance Level e	Reversing a movement/up to category 4, Performance Level e
Note on forced checking procedure	Switching frequency min. 1/week		
Certificate issuing authority	IFA 1004008	IFA 1204006	IFA 1004008
CE marking (see declaration of conformity)	To EC Machinery Directive		
	To EU EMC Directive ¹⁾		
Max. positive test pulse with 0 signal ²⁾	[μs]	1000	
Max. negative test pulse with 1 signal ²⁾	[μs]	800	
Shock resistance ²⁾	Shock test with severity level 2, to EN 60068-2-27		
Vibration resistance ²⁾	Transport application test with severity level 2, to EN 60068-2-6		

1) For information about the area of use, see the EC declaration of conformity at: www.festo.com/catalogue/... → Support/Downloads.

If the devices are subject to usage restrictions in residential, commercial or light-industrial environments, further measures for the reduction of the emitted interference may be necessary.

2) Please also note the safety-related applications and safety technology on the Support Portal

General technical data			
Control block	VOFA-L26-T52-...	VOFA-L26-T32C-...	VOFA-B26-T52-... on valve terminal
Design	Piston spool valve		
Standard nominal flow rate	[l/min]	950	1050
Standard flow rate exhaust 6 → 0 bar ¹⁾	[l/min]	–	2650
Standard flow rate exhaust 6 → 0 bar in the event of a fault ^{1),2)}	[l/min]	–	1050
Reset method	Mechanical spring		
Sealing principle	Soft		
Exhaust air function	Can be throttled		
Actuation type	Electrical		
Overlap	Positive overlap		
Type of control	Piloted		
Flow direction	Not reversible		
Exhaust air function	Can be throttled		
Suitability for vacuum	–		
Pilot air supply	Internal		Via valve terminal
Type of mounting	Via through-hole, on manifold sub-base		
Mounting position	Any		
Manual override	–		
Signal status indication, valve	Via accessories		
Pneumatic connections			
Supply port	1	G1/4	G1/4
Exhausting	3/5	G1/4	G1/4 (3 only)
Working ports	2/4	G1/4	G1/4 (2 only)
Pilot air supply	14	–	–
Pressure gauge		G1/4	–
			Via the manifold sub-base of the valve terminal
			G1/4

1) Measured in direction of exhaust (2→3), P = 6 bar measured with respect to atmosphere with silencer UO-1/4

2) A fault means: Failure of one of the two directional control valves to switch back completely.

Data sheet

Operating and environmental conditions			
Control block	VOFA-L26-T52-...	VOFA-L26-T32C-...	VOFA-B26-T52-... on valve terminal
Operating medium	Compressed air to ISO 8573-1:2010 [7:4:4]		
Pilot medium	Compressed air to ISO 8573-1:2010 [7:4:4]		
Notes concerning operating/pilot medium	Lubricated operation possible (in which case lubricated operation will always be required)		
Operating pressure [bar]	3 ... 10		0 ... 10
Operating pressure for valve terminal with internal pilot air supply [bar]	–		3 ... 10
Pilot pressure [bar]	3 ... 10		
Noise level LpA [dB(A)]	85		
Ambient temperature [°C]	–5 ... +50		
Temperature of medium [°C]	–5 ... +50		
Nominal altitude of use [m]	1000 to VDE 0580		
Corrosion resistance class CRC ¹⁾	0		
Certification	c UL us - Recognized (OL)		–
Certificate issuing authority	UL MH19482		–
KC mark	KC EMC		–

1) Corrosion resistance class CRC 0 to Festo standard FN 940070

No corrosion stress. Applies to small, visually unimportant standards-based parts such as threaded pins, circlips and clamping sleeves which are usually only available on the market in a phosphated or burnished version (and possibly oiled) as well as to ball bearings (for components < CRC 3) and plain bearings.

Electrical data – Control block			
Control block	VOFA-L26-T52-...	VOFA-L26-T32C-...	VOFA-B26-T52-... on valve terminal
Electrical connection	Plug to EN 175301-803, type C, without PE conductor		
Nominal operating voltage [V DC]	24		
Permissible voltage fluctuations [%]	–15/+10		
Surge resistance [kV]	2.5		
Pollution degree	3		
Power consumption [W]	1.8		
Max. magnetic disruption field [mT]	60		
Piston position sensing	Normal position via sensor		
Switching position indication	Via accessories		
Duty cycle ED [%]	100		
Degree of protection to EN 60529	IP65, NEMA 4 (for all types of signal transmission in mounted state)		
Protection against direct and indirect contact	PELV Protected to EN 60950/IEC 950		
Valve switching time	On [ms]	22	24
	Off [ms]	56	54
Valve sensor	On [ms]	60	58
switching time ¹⁾	Off [ms]	11	11

1) Valve sensor switching time off: period of time from the coil being energised to sensor being switched off when using a PNP sensor.
Valve sensor switching time on: period of time from the coil being de-energised to 0-L edge at the sensor when using a PNP sensor.

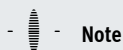
**Note**

With a duty cycle of 100%, the control block must be de-energised once a week.

Data sheet

Electrical data – Sensor (to EN -60947-5-2)	
Electrical connection	Cable, 3-wire Plug M8x1, 3-pin
Cable length [m]	2.5
Switching output	PNP or NPN
Switching element function	N/C contact
Signal status indication	Yellow LED
Operating voltage range [V DC]	10 ... 30
Residual ripple [%]	±10
Sensor no-load supply current [mA]	Max. 10
Max. output current [mA]	200
Voltage drop [V]	Max. 2
Max. switching frequency [Hz]	5000
Short circuit current rating	Pulsed
Reverse polarity protection for sensor	For all electrical connections
Measuring principle	Inductive

Materials	
Sub-base/manifold sub-base	Wrought aluminium alloy
Housing	Die-cast aluminium, PA
Seals	NBR, FPM, HNBR
Screws	Galvanised steel
Sensor housing	High-alloy stainless steel
Note on materials	RoHS-compliant

Data sheet

Dimensions

Download CAD data → www.festo.com

Decentralised individual connection variant, VOFA-L26-T52-...

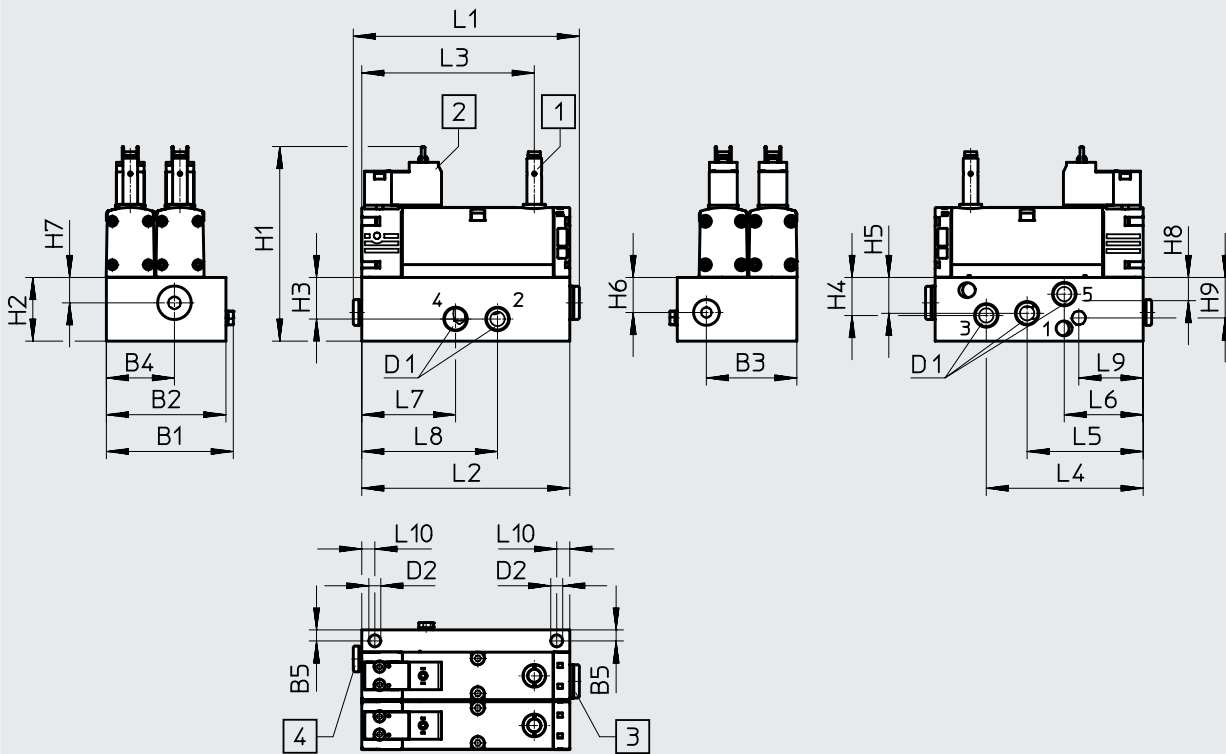

[1] Proximity switch PNP or NPN, size M8x1, plug connection to EN 61076-2-104

[2] Electrical connection to EN 175301-803, type C

[3] Pneumatic connection G1/4 sealed with blanking plug

[4] Pneumatic connection G1/8 sealed with blanking plug

Type	B1	B2	B3	B4	B5	D1	D2	H1	H2	H3	H4	H5	H6
VOFA-L26-T52-M-G14-1C1-APP	69	65	49.3	37	6	G1/4	6.5	105.8	34.6	22.6	20.7	19.5	19.1
VOFA-L26-T52-M-G14-1C1-ANP													

Type	H7	H8	H9	L1	L2	L3	L4	L5	L6	L7	L8	L9	L10
VOFA-L26-T52-M-G14-1C1-APP	13.8	9.1	22	122.9	113.1	93.8	85.3	63.1	42.9	51	73.8	35	7.1
VOFA-L26-T52-M-G14-1C1-ANP													

Data sheet

Dimensions

Download CAD data → www.festo.com

Decentralised individual connection variant VOFA-L26-T32C-...

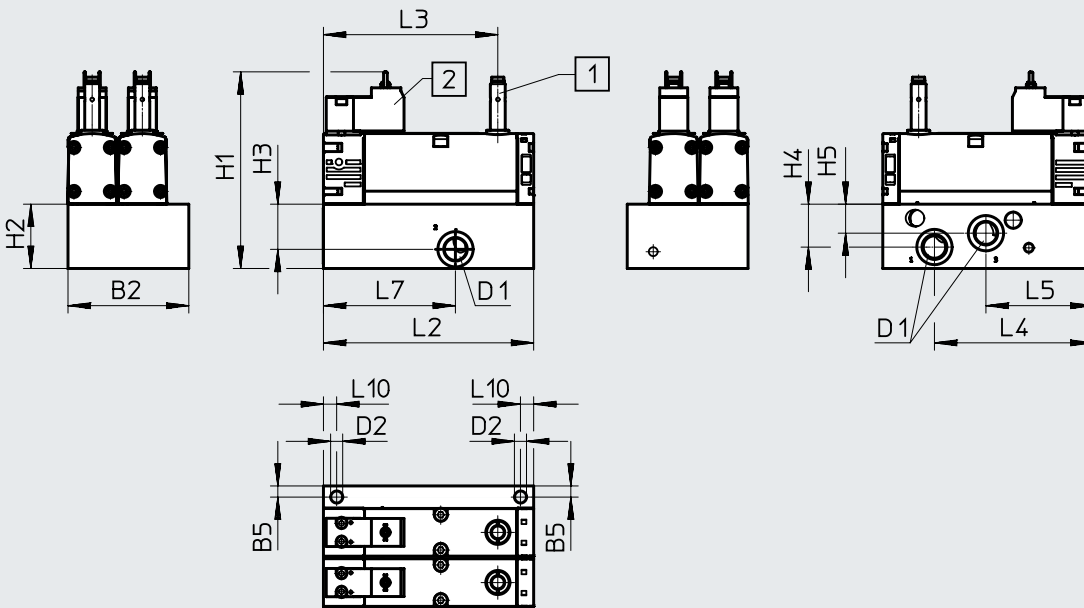

- [1] Proximity switch PNP or NPN, size M8x1, plug connection to EN 61076-2-104
- [2] Electrical connection to EN 175301-803, type C

Type	B2	B5	D1	D2	H1	H2	H3	H4	H5	L2	L3	L4	L5	L7	L10
VOFA-L26-T32C-M-G14-1C1-APP	65	6	G1/4	6.5	105.8	34.6	24.3	23.1	15.6	113.1	93.8	85.3	57.6	71	7.1
VOFA-L26-T32C-M-G14-1C1-ANP															

Version for valve terminal VTSA/VTSA-F, VOFA-B26-T52-...

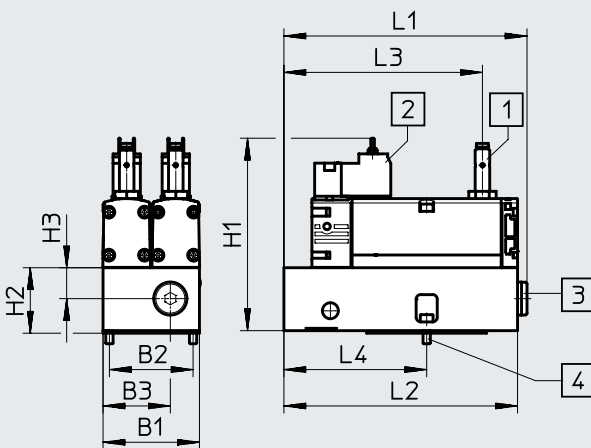

- [1] Proximity switch PNP or NPN, size M8x1, plug connection to EN 61076-2-104
- [2] Electrical connection to EN 175301-803, type C
- [3] Pneumatic connection G1/4 sealed with blanking plug
- [4] 2x screw with internal hexagon (width across flats 2.5), M4x12 (included in the scope of delivery)

Type	B1	B2	B3	H1	H2	H3	L1	L2	L3	L4
VOFA-B26-T52-M-1C1-APP	53	46	37	105.8	34.6	17	133.7	128.5	109.2	78.5
VOFA-B26-T52-M-1C1-ANP										

Data sheet

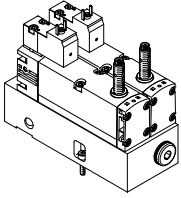
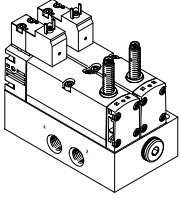
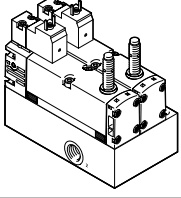
Ordering data							
Valve function	Code	Switching output	Width [mm]	Weight [g]	Part no.	Type	
Control block, version for valve terminal VTSA/VTSA-F							
	5/2-way valve, single solenoid, mechanical spring return, with switching position sensing via inductive sensor and 3-pin sensor push-in connector M8, mounted on intermediate plate for pneumatic interlinking	SP ²⁾	PNP	53	1112	– ¹⁾	VOFA-B26-T52-M-1C1-APP
		SN ²⁾	NPN	53	1112	– ¹⁾	VOFA-B26-T52-M-1C1-ANP
Control block, as decentralised individual connection variant							
	5/2-way single solenoid valve, mechanical spring return, with switching position sensing via inductive sensor and 3-pin sensor push-in connector M8, mounted on individual sub-base	–	PNP	65	1138	569819	VOFA-L26-T52-M-G14-1C1-APP
		–	NPN	65	1138	569820	VOFA-L26-T52-M-G14-1C1-ANP
	Function as 3/2-way solenoid valve, normally closed, mechanical spring return, with switching position sensing via inductive sensor and 3-pin sensor push-in connector M8, mounted on individual sub-base	–	PNP	65	1134	574011	VOFA-L26-T32C-M-G14-1C1-APP
		–	NPN	65	1134	574012	VOFA-L26-T32C-M-G14-1C1-ANP

1) The control block with safety function can only be ordered via the valve terminal configurator and therefore does not have a separate part number.

2) Code letter within the order code for a valve terminal configuration

 **Note**

Silencers – Failure of safety function (VOFA-L26-T32C-...)

The addition of commercially available silencers can cause errors ranging from a reduction in exhaust performance to complete failure of the safety function.

In order to avoid such errors, proceed as follows:





- Use a silencer of type UO-1/4 or equivalent type
- Do not use sintered metal silencers
- When using a silencer, make sure the exhaust is unobstructed (exhaust outlet should have a minimum axial clearance of 15 mm)
- The silencer and exhaust (port 3) must not be blocked

 **Note**

Sensors

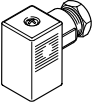
The sensors integrated in the valves must not be replaced by the customer. Incorrect assembly can result in malfunctions or damage to the valve. Please contact Festo in the event of a malfunction.

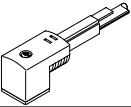
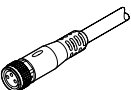
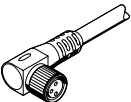
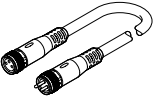
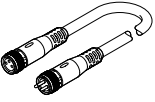
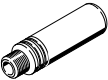
Data sheet

Ordering data		Description	Part no.	Type	
Plug socket for electrical connection of individual valves					
	Angled socket, 3-pin, screw terminal, fitting	PG7	151687	MSSD-EB	
		M12	539712	MSSD-EB-M12	
Illuminating seal for plug pattern to EN 175301-803, type C					
	For plug socket MSSD		151717	MEB-LD-12-24DC	
Connecting cable for electrical connection of individual valves					
	Angled socket, 3-pin, with signal status indication via LED	2.5 m	151688	KMEB-1-24-2.5-LED	
		5 m	151689	KMEB-1-24-5-LED	
		10 m	193457	KMEB-1-24-10-LED	
Connecting cable for the electrical connection of sensors for switching position sensing					
	<ul style="list-style-type: none"> • Straight socket, M8x1, 3-pin • Open end, 3-wire 	2.5 m	541333	NEBU-M8G3-K-2.5-LE3	
		5 m	541334	NEBU-M8G3-K-5-LE3	
	<ul style="list-style-type: none"> • Angled socket, rotatable, M8x1, 3-pin • Open end, 3-wire 	2.5 m	8001660	NEBU-M8R3-K-2.5-LE3	
		5 m	8001661	NEBU-M8R3-K-5-LE3	
	Straight socket, straight plug, 3-pin, 4-pin plug M8	2.5 m	554037	NEBU-M8G3-K-2.5-M8G4	
	Modular system for a choice of connecting cables	-	-	NEBU-... → Internet: nebu	
Silencer					
	Connecting thread	G1/4	197584	UO-1/4	
Push-in fitting					
	Connecting thread G1/4 for tubing O.D.	8 mm	10 pieces	186099	QS-G1/4-8
		10 mm	10 pieces	186101	QS-G1/4-10
		12 mm	10 pieces	186350	QS-G1/4-12
Blanking plug					
	Connecting thread	G1/4	10 pieces	3569	B-1/4