

## Pressure transmitters SPTE

**FESTO**



## Key features

### At a glance

- Compact design
- Very lightweight
- Various pneumatic connection options
- Output signal: 0 ... 10 V or 1 ... 5 V
- Choice of pressure ranges

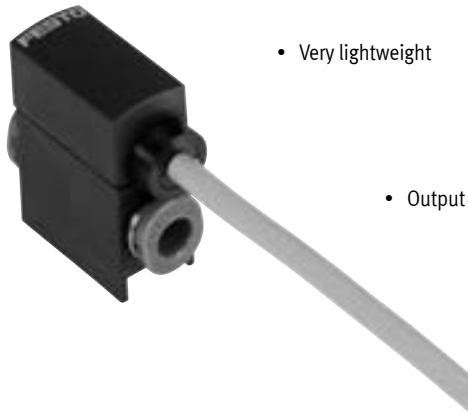

### Pneumatic connections



Push-in sleeve



Push-in connector



Flange



Cartridge

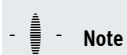

#### Note

The version with 10 mm cartridge is designed for the vacuum generator OVEL.

### Use with SCDN



- One or two SPTE pressure transmitters can be connected to a signal converter SCDN
- Measured value indicator with selection of units
- Blue display with high-contrast white text and red switchover
- IO-Link/2x PNP or NPN switching outputs
- Min./max. monitoring

## Peripherals overview

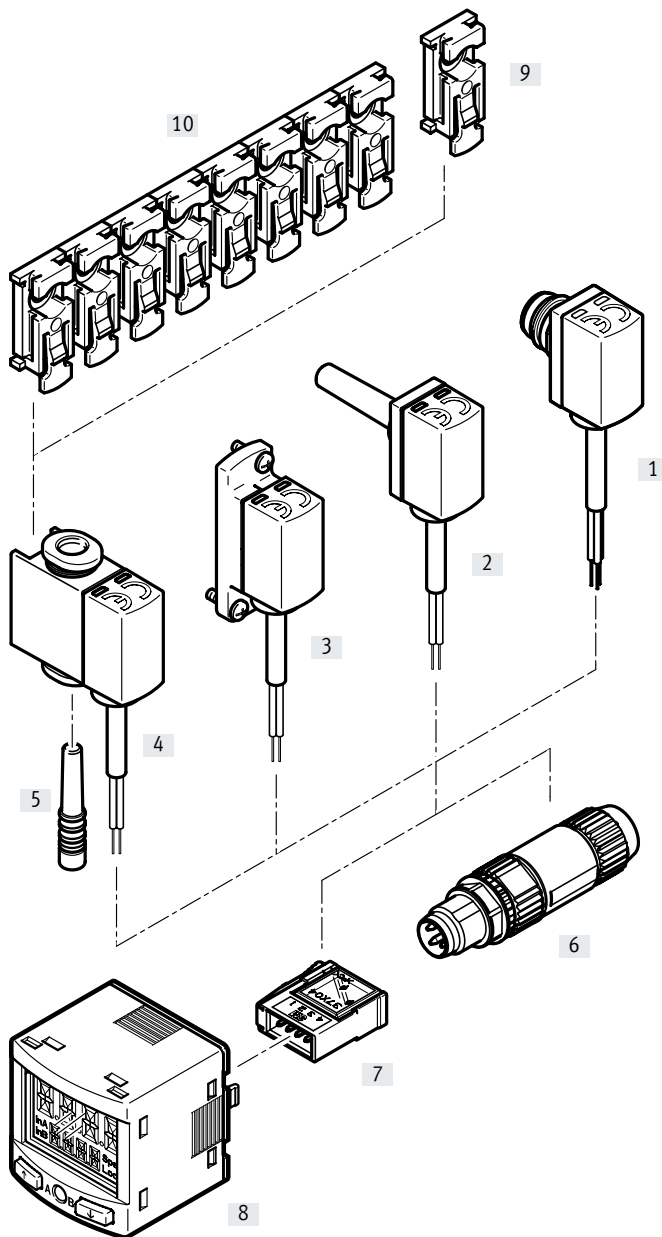

Accessories		→ Page/Internet
[1]	Pressure transmitter SPTE-...-PC10-...	5
[2]	Pressure transmitter SPTE-...-S-...	5
[3]	Pressure transmitter SPTE-...-F-...	5
[4]	Pressure transmitter SPTE-...-Q-...	5
[5]	Blanking plug QSMC-3H (included in the scope of delivery with SPTE-...-Q-...)	qs
[6]	Plug NECU-S-M8G3-HX-Q3	10
[7]	Plug NECU-S-ECG4-HX-Q3	10
[8]	Signal converter SCDN-2V-EC4-PNLK-L1	scdn
[9]	Mounting clip SAMH-PE-MC-1	10
[10]	Mounting clip SAMH-PE-MC-8	10

Type codes

<b>001</b>	<b>Series</b>
<b>SPTE</b>	Pressure transmitter

<b>002</b>	<b>Pressure measuring range</b>
<b>B2</b>	-1 ... 1 bar
<b>V1</b>	0 ... -1 bar
<b>P10</b>	0 ... 10 bar

<b>003</b>	<b>Pressure inlet</b>
<b>R</b>	Relative pressure

<b>004</b>	<b>Pneumatic connection</b>
<b>F</b>	Flange/sub-base
<b>Q3</b>	Push-in connector 3 mm
<b>Q4</b>	Push-in connector 4 mm
<b>S4</b>	Push-in sleeve 4 mm
<b>S6</b>	Push-in sleeve 6 mm
<b>PC10</b>	Cartridge 10 mm

<b>005</b>	<b>Electrical output 1</b>
<b>B</b>	1 ... 5 V
<b>V</b>	0 ... 10 V

<b>006</b>	<b>Electrical connection</b>
<b>2.5K</b>	Cable 2.5 m, open end

## Data sheet

### Function

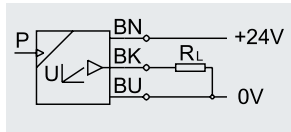

- - Voltage  
10 ... 30 V DC

- - Pressure  
-1 ... +10 bar

- - Temperature range  
0 ... +50°C



### General technical data

Certification	RCM c UL us - Recognized (OL)
CE marking (see declaration of conformity) <sup>1)</sup>	To EU EMC Directive
Note on materials	RoHS-compliant

### Input signal/measuring element

SPTE: ... -	V1R	B2R	P10R
Measured variable	Relative pressure		
Measurement method	Piezoresistive pressure sensor		
Pressure measuring range start value [bar]	0	-1	0
Pressure measuring range end value [bar]	-1	1	10
Max. overload pressure [bar]	5	5	15
Operating medium	Compressed air to ISO 8573-1:2010 [7:4:4]		
Note on the operating/pilot medium	Lubricated operation possible		
Temperature of medium [°C]	0 ... +50		
Ambient temperature [°C]	0 ... +50		

### Output, general

Accuracy ±FS <sup>2)</sup> [%]	3 (at room temperature of approx. 23°C) 4 (in ambient temperature range 0 ... 50°C)
Repetition accuracy ±FS <sup>2)</sup> [%]	0.3
Temperature coefficient ±FS/K <sup>2)</sup> [%]	0.05

### Analogue output

SPTE: ... -	-B-	-V-
Analogue output [V]	1 ... 5	0 ... 10
Rise time [ms]	1	
Min. load resistance of voltage output [kΩ]	15	

1) For information about the area of use, see the EC declaration of conformity at: [www.festo.com/catalogue/SPTE](http://www.festo.com/catalogue/SPTE) → Support/Downloads.

If the devices are subject to usage restrictions in residential, commercial or light-industrial environments, further measures for the reduction of the emitted interference may be necessary.

2) % FS = % of the measuring range (full scale)

## Data sheet

Output, additional data						
Short circuit current rating	For all electrical connections					
Electronics						
SPTE-...-	-B-				-V-	
Operating voltage range DC	[V]	10 ... 30		18 ... 30		
Reverse polarity protection	For all electrical connections					
Electromechanics						
Electrical connection	Cable, 3-wire, open end					
Cable length	[m]	2.5				
Mechanics						
SPTE-...-	S4	S6	Q3	Q4	F	PC10
Type of mounting	Plug-in		Via accessories		With through-hole and screw	Pin-type connection
Mounting position	Any					
Pneumatic connection	Push-in sleeve QS-4	Push-in sleeve QS-6	QS-3	QS-4	Flange	Cartridge 10 mm
Product weight	[g]	35				
Information on materials: housing	PA-reinforced					
Immission/emission						
Degree of protection	IP40					
Corrosion resistance class CRC <sup>1)</sup>	2					

1) Corrosion resistance class CRC 2 to Festo standard FN 940070

Moderate corrosion stress. Indoor applications in which condensation can occur. External visible parts with primarily decorative surface requirements which are in direct contact with a normal industrial environment.

Data sheet

Dimensions

Download CAD data → [www.festo.com](http://www.festo.com)

SPTE-...S...

[1] Pneumatic connection

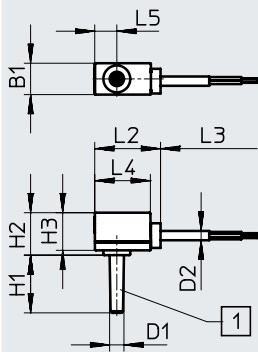

Type	B1	D1 ∅	D2 ∅	H1	H2	H3	L2	L3	L4	L5
SPTE-...S4	9.8	4	2.9	18	13.3	11.8	20.5	2500	17.5	6.9
SPTE-...S6		6		18	13.3	11.8				6.9

SPTE-...Q...

[1] Blanking plug  
[2] Pneumatic connection

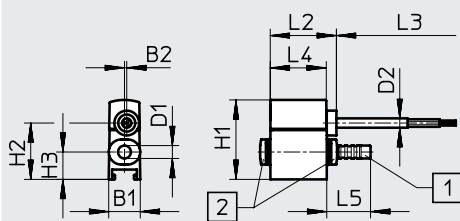

Type	B1	B2	D1 ∅	D2 ∅	H1	H2	H3	L2	L3	L4	L5
SPTE-...Q3	9.8	0.7	3	2.9	24.7	17.5	8.5	20.5	2500	17.5	13.6
SPTE-...Q4		0.7	4		24.7	17.5	8.5				13.6

Data sheet

Dimensions

Download CAD data → [www.festo.com](http://www.festo.com)

SPTE...-F

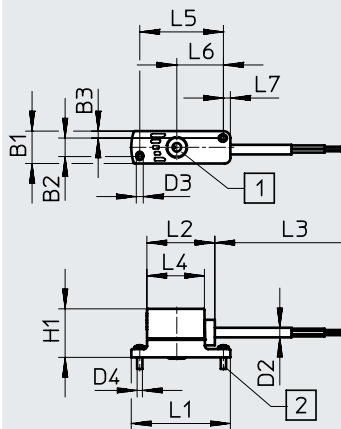

- [1] Pneumatic connection with O-ring for flat mounting
- [2] Screw M2x6

Type	B1	B2	B3	D2 ∅	D3 ∅	D4	H1	L1	L2	L3	L4	L5	L6	L7
SPTE...-F	9.8	5.4	2.1	2.9	2.1	M2x6	15	30	20.5	2500	17.5	25	13.9	2.3

SPTE...PC10...

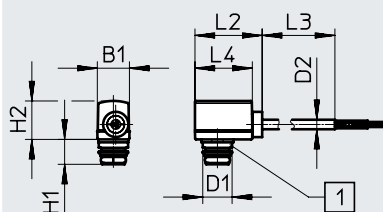

- [1] Supply port: pin-type cartridge 10 mm

Type	B1	D1 ∅	D2 ∅	H1	H2	L2	L3	L4
SPTE-V1R-PC10-V...	9.8	8.9	2.9	7.6	11.7	20.5	2500	17.5
SPTE-V1R-PC10-B...								
SPTE-B2R-PC10-V...								
SPTE-B2R-PC10-B...								



## Data sheet

Ordering data						
Pressure measuring range <sup>1)</sup> [bar]	Analogue output [V]	Pneumatic connection	Electrical connection	Part no.	Type	
-1 ... 1	1 ... 5	Cartridge 10 mm	Cable, 3-wire, open end	8025977	SPT-B2R-PC10-B-2.5K	
	0 ... 10			8025976	SPT-B2R-PC10-V-2.5K	
0 ... -1	1 ... 5	Cartridge 10 mm		8025975	SPT-V1R-PC10-B-2.5K	
		Push-in sleeve 4 mm		571469	SPT-V1R-S4-B-2.5K	
		Push-in sleeve 6 mm		571470	SPT-V1R-S6-B-2.5K	
		Push-in connector 3 mm		571471	SPT-V1R-Q3-B-2.5K	
		Push-in connector 4 mm		571472	SPT-V1R-Q4-B-2.5K	
		Flange		571473	SPT-V1R-F-B-2.5K	
	0 ... 10	Cartridge 10 mm		8025974	SPT-V1R-PC10-V-2.5K	
				Push-in sleeve 4 mm	571474	SPT-V1R-S4-V-2.5K
				Push-in sleeve 6 mm	571475	SPT-V1R-S6-V-2.5K
				Push-in connector 3 mm	571476	SPT-V1R-Q3-V-2.5K
0 ... 10	1 ... 5	Push-in connector 4 mm		571477	SPT-V1R-Q4-V-2.5K	
		Flange		571478	SPT-V1R-F-V-2.5K	
		Push-in sleeve 4 mm	571479	SPT-P10R-S4-B-2.5K		
		Push-in sleeve 6 mm	571480	SPT-P10R-S6-B-2.5K		
		Push-in connector 3 mm	571481	SPT-P10R-Q3-B-2.5K		
		Push-in connector 4 mm	571482	SPT-P10R-Q4-B-2.5K		
	0 ... 10	Flange	571483	SPT-P10R-F-B-2.5K		
			Push-in sleeve 4 mm	571484	SPT-P10R-S4-V-2.5K	
			Push-in sleeve 6 mm	571485	SPT-P10R-S6-V-2.5K	
			Push-in connector 3 mm	571486	SPT-P10R-Q3-V-2.5K	
			Push-in connector 4 mm	571487	SPT-P10R-Q4-V-2.5K	
			Flange	571488	SPT-P10R-F-V-2.5K	

1) Additional pressure ranges on request (batch size 80)

## Accessories

### Mounting clip SAMH-PE-MC-1

Material:  
POM

Note on materials:  
RoHS-compliant

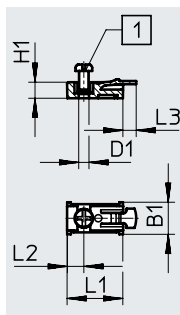

[1] M3x6 screw (included in the scope of delivery)

#### Dimensions and ordering data

B1	D1 ∅	H1	L1	L2	L3	Part no.	Type
10	3.2	5	17.5	5.3	4	571489	SAMH-PE-MC-1

### Mounting clip SAMH-PE-MC-8

Material:  
POM

Note on materials:  
RoHS-compliant

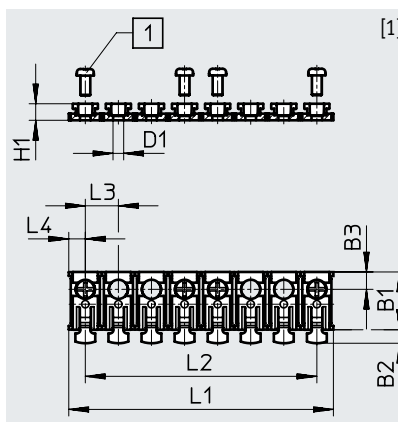

[1] M3x6 screw (4 included in the scope of delivery)

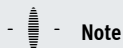

#### Note

The mounting clip SAMH-PE-MC-8 can be shortened by the user to the required number of slots.

#### Dimensions and ordering data

B1	B2	B3	D1 ∅	H1	L1	L2	L3	L4	Part no.	Type
17.5	4	5.3	3.2	5	80	70	10	5	571490	SAMH-PE-MC-8

#### Ordering data – Plugs

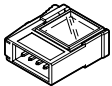
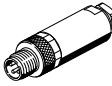
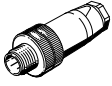
Electrical connection	Part no.	Type
 <p>Straight plug, 4-pin, square design, insulation displacement connector</p>	570922	NECU-S-ECG4-HX-Q3
 <p>Plug M8x1, straight, 3-pin, insulation displacement connector</p>	564945	NECU-S-M8G3-HX-Q3
 <p>Straight plug, 4-pin, straight, screw terminal</p>	192008	SEA-4GS-7-2.5