

Pressure sensors SPAE

FESTO



Key features

At a glance

- Single-button operation
- 7-segment display
- Various pneumatic connection options
- Choice of pressure ranges
- Switching status indication



Function

The SPAE is an electronic pressure sensor with piezoresistive pressure measuring cell, integrated signal processing, pressure indicator with percentage, control button and a switching output, PNP/NPN switchable. Two switching signals and the measured value can be transmitted via IO-Link.

- The sensor can be set using the key and display or alternatively using IO-Link or teach-in
- Switching functions: threshold value or window comparator
- Switching logic: normally open (NO) or normally closed (NC)
- Threshold values and hysteresis are adjustable
- Display of minimum and maximum measured values
- Display can be rotated and switched off
- Protection against tampering using security code
- All parameters that have been input can be transferred to other SPAE (replicator function)

Measurement method	Pressure measuring range	Measured variable	Pneumatic connection	Output	Electrical connection
	[bar]				
Piezoresistive pressure sensor	-1 ... +1 0 ... -1	Relative pressure	Cartridge 10 mm	PNP/NPN switchable, IO-Link	Cable, 3-wire open end
			Push-in sleeve 4 mm		
			Push-in sleeve 6 mm		
			Push-in connector 3 mm		
			Push-in connector 4 mm		
			Flange		
	0 ... 10		Cartridge 10 mm		
			Push-in sleeve 4 mm		
			Push-in sleeve 6 mm		
			Push-in connector 3 mm		
			Push-in connector 4 mm		
			Flange		

Note
The version with 10 mm cartridge is designed for the vacuum generator OVEL.

Peripherals overview

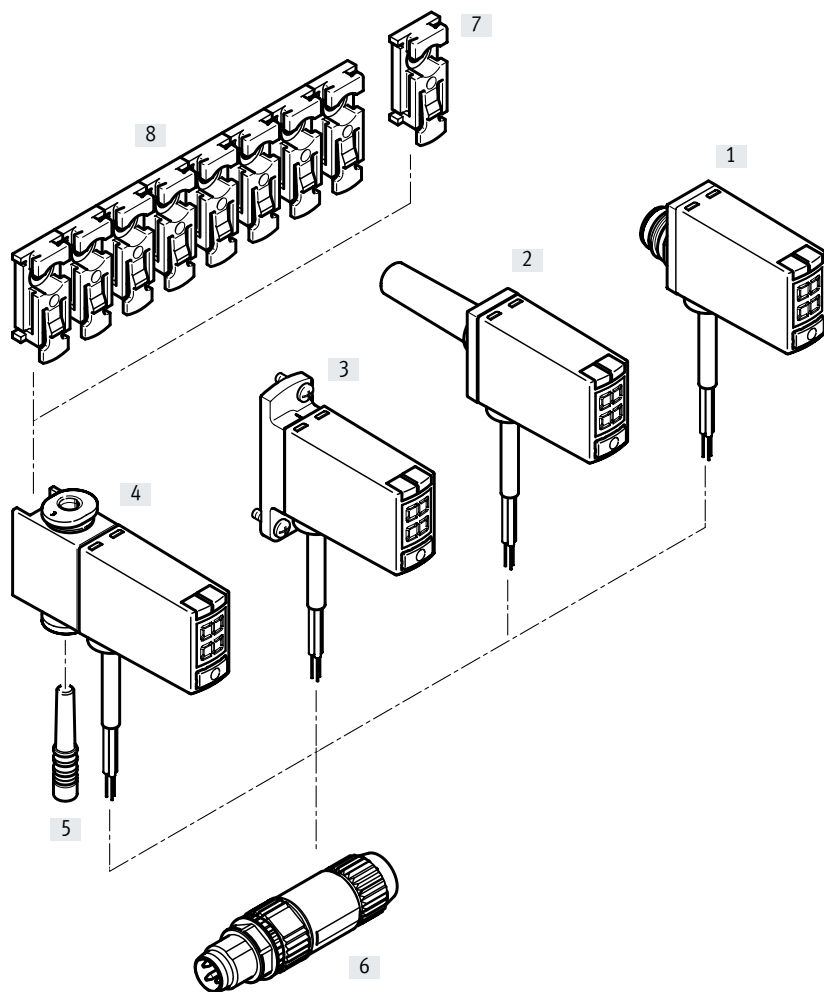

Accessories		→ Page/Internet
[1]	Pressure sensor SPAE-...-PC10...	5
[2]	Pressure sensor SPAE-...-S...	5
[3]	Pressure sensor SPAE-...-F...	5
[4]	Pressure sensor SPAE-...-Q...	5
[5]	Blanking plug (included in the scope of delivery of SPAE-...-Q...)	qs
[6]	Plug NECU-S-M8G3-HX-Q3	10
[7]	Mounting clip SAMH-PE-MC-1	10
[8]	Mounting clip SAMH-PE-MC-8	10

Type codes

001	Series	
SPAE	Pressure sensor	

002	Pressure measuring range	
P10	0 ... 10 bar	
V1	0 ... -1 bar	
B2	-1 ... 1 bar	

003	Pressure inlet	
R	Relative pressure	

004	Pneumatic connection	
S4	Push-in sleeve 4 mm	
S6	Push-in sleeve 6 mm	
Q3	Push-in connector 3 mm	
Q4	Push-in connector 4 mm	
F	Flange/sub-base	
PC10	Cartridge 10 mm	

005	Electrical output 1	
PNLK	PNP/NPN/IO-Link	

006	Electrical connection	
2.5K	Cable 2.5 m, open end	



 **Note**

Pressure measuring range: Additional pressure ranges on request (batch size 80)

Data sheet

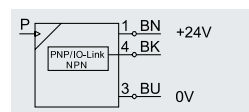
Function



-  Voltage
18 ... 30 V DC
-  Pressure measuring range
-1 ... +10 bar
-  Temperature range
0 ... +50°C



General technical data

Certification	RCM c UL us - Recognized (OL)
Degree of protection	IP40
Note on materials	RoHS-compliant
Corrosion resistance class CRC ¹⁾	2
CE marking (see declaration of conformity)	To EU EMC Directive ²⁾

- 1) Corrosion resistance class CRC 2 to Festo standard FN 940070
Moderate corrosion stress. Indoor applications in which condensation can occur. External visible parts with primarily decorative surface requirements which are in direct contact with a normal industrial environment.
- 2) For information about the area of use, see the EC declaration of conformity at: www.festo.com/catalogue/... → Support/Downloads.
If the devices are subject to usage restrictions in residential, commercial or light-industrial environments, further measures for the reduction of the emitted interference may be necessary.

Input signal for measuring element	V1R	B2R	P10R
Measured variable	Relative pressure		
Measurement method	Piezoresistive pressure sensor with display		
Pressure measuring range start value [bar]	0	-1	0
Pressure measuring range end value [bar]	-1	1	10
Max. overload pressure [bar]	5	5	15
Operating medium	Compressed air to ISO 8573-1:2010 [7:4:4]		
Note on the operating/pilot medium	Lubricated operation possible		
Temperature of medium [°C]	0 ... +50		
Ambient temperature [°C]	0 ... +50		

Signal processing

Resolution ADC	10 bits
----------------	---------

Output, general

Accuracy [% FS]	1.5 at room temperature
Repetition accuracy [% FS]	0.3
Temperature coefficient [% FS/K]	Typically 0.05

Switching output

Switching output	PNP/NPN, switchable
Switching function	Freely programmable
Switching element function	N/C or N/O contact, switchable
Switch-on time [ms]	1
Switch-off time [ms]	1
Max. output current [mA]	100
Short circuit current rating	Yes

Data sheet

Measured value display	
Display range start value	[% FS] 0
Display range end value	[% FS] 99

Communication interface	
Protocol	IO-Link
IO-Link, protocol version	Device V 1.1
IO-Link, profile	Smart sensor profile
IO-Link, function classes	Binary data channel (BDC)
	Diagnostics
	Identification
	Process data variable (PDV)
	Teach channel
IO-Link, communication mode	COM2 (38.4 kBd)
IO-Link, port class	A
IO-Link, process data width OUT	0 byte
IO-Link, process data width IN	2 bytes
IO-Link, process data contents IN	2 bit BDC (pressure monitoring)
	14 bit PDV (pressure measured value)
IO-Link, minimum cycle time	[ms] 3
IO-Link, SIO mode support	Yes
IO-Link, data memory required	0.5 KB

Electronics	
Operating voltage range DC	[V] 18 ... 30
Reverse polarity protection	For all electrical connections

Electromechanical systems	
Electrical connection	Cable, 3-wire open end
Cable length	[m] 2.5

Mechanical system	S4	S6	Q3	Q4	F	PC10
Type of mounting	Plug-in		With accessories		Through-hole and screw	Pin-type connection
Mounting position	Any					
Pneumatic connection	Push-in sleeve QS-4	Push-in sleeve QS-6	QS3	QS4	Flange	Cartridge 10 mm

Mechanical system, general	
Product weight	[g] 40
Information on housing materials	Reinforced PA

Display/operation	
Display type	LED display, 2-digit
Displayable units	% FS
Switching status indication	Yellow LED
Setting options	Via display and keys, teach-in, IO-Link
Threshold value setting range	[%] 1 ... 98
Protection against tampering	PIN code

Data sheet

Dimensions

Download CAD data → www.festo.com

SPAE...S.....

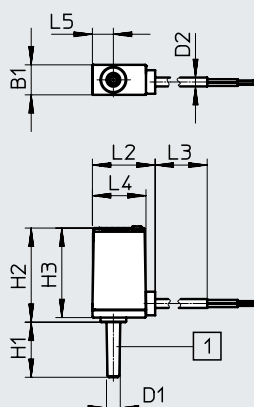

[1] Supply port, push-in sleeve
for SPAE-S4
for SPAE-S6

Type	B1	D1 ∅	D2 ∅	H1	H2	H3	L2	L3	L4	L5
SPAE-V1R-S4-...	9.8	4	2.9	18	30.8	29.3	20.5	2500	17.5	6.9
SPAE-V1R-S6-...		6		21						
SPAE-P10R-S4-...		4		18						
SPAE-P10R-S6-...		6		21						

SPAE...Q.....

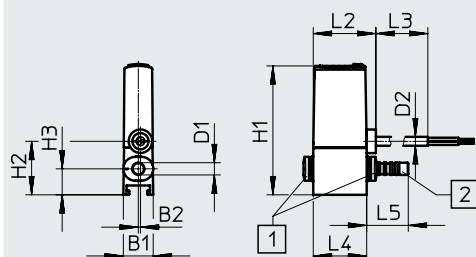

[1] Supply port on both sides
for SPAE-Q3 / QSIK-M-3-X
for SPAE-Q4 / QSIK-M-4-X
[2] Blanking plug
for SPAE-Q3 / QSMC-3H
for SPAE-Q4 / QSC-4H
supplied

Type	B1	B2	D1 ∅	D2 ∅	H1	H2	H3	L2	L3	L4	L5
SPAE-V1R-Q3-...	9.8	0.7	3	2.9	~42	17.5	8.5	20.5	2500	17.5	13.6
SPAE-V1R-Q4-...			4								16.6
SPAE-P10R-Q3-...			3								13.6
SPAE-P10R-Q4-...			4								16.6

Data sheet

Dimensions

Download CAD data → www.festo.com

SPAE...F...

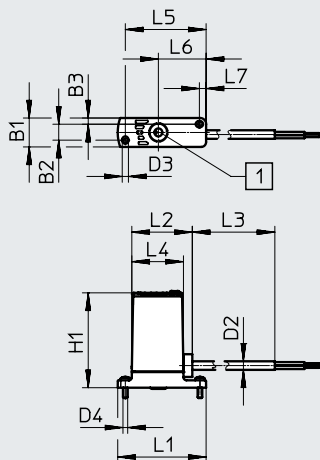

[1] Supply port with O-ring for flat mounting with SPAE-F

Type	B1	B2	B3	D2 ∅	D3 ∅	D4	H1	L1	L2	L3	L4	L5	L6	L7
SPAE-V1R-F...	9.8	~5.4	2.1	2.9	2.1	M2x6	~32	30	20.5	2500	17.5	25	13.9	2.3
SPAE-P10R-F...														



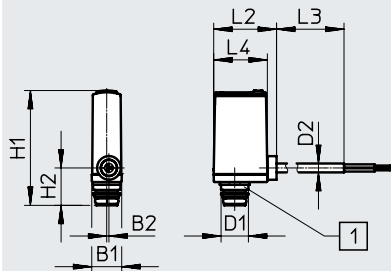





SPAE...PC10...



[1] Supply port: pin-type cartridge 10 mm with SPAE-PC-10

Type	B1	B2	D1 ∅	D2 ∅	H1	H2	L2	L3	L4
SPAE-V1R-PC10-...	9.8	0.7	8.9	2.9	~37.5	12.2	20.5	2500	17.5
SPAE-B2R-PC10-...									

Data sheet

Ordering data	Pressure measuring range ¹⁾	Pneumatic connection	Electrical connection	Part no.	Type	
	0 ... -1 bar	Push-in sleeve 4 mm	Cable, 3-wire open end	8001440	SPAE-V1R-S4-PNLK-2.5K	
		Push-in sleeve 6 mm		8001441	SPAE-V1R-S6-PNLK-2.5K	
		Push-in connector 3 mm		8001442	SPAE-V1R-Q3-PNLK-2.5K	
		Push-in connector 4 mm		8001443	SPAE-V1R-Q4-PNLK-2.5K	
		Flange		8001444	SPAE-V1R-F-PNLK-2.5K	
				Cartridge 10 mm	8025978	SPAE-V1R-PC10-PNLK-2.5K
				0 ... 10 bar	Push-in sleeve 4 mm	8001445
		Push-in sleeve 6 mm			8001446	SPAE-P10R-S6-PNLK-2.5K
		Push-in connector 3 mm			8001447	SPAE-P10R-Q3-PNLK-2.5K
		Push-in connector 4 mm			8001448	SPAE-P10R-Q4-PNLK-2.5K
	Flange	8001449	SPAE-P10R-F-PNLK-2.5K			
		-1 ... 1 bar	Cartridge 10 mm		8025979	SPAE-B2R-PC10-PNLK-2.5K

1) Additional pressure ranges on request (batch size 80)

Accessories

Mounting clip SAMH-PE-MC-1

Material:
POM

Note on materials:
RoHS-compliant

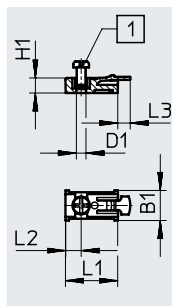

[1] M3x6 screw (included in the scope of delivery)

Dimensions and ordering data

B1	D1 ∅	H1	L1	L2	L3	Part no.	Type
10	3.2	5	17.5	5.3	4	571489	SAMH-PE-MC-1

Mounting clip SAMH-PE-MC-8

Material:
POM

Note on materials:
RoHS-compliant

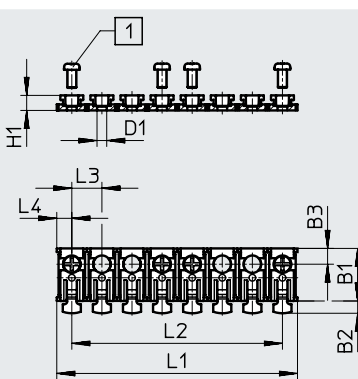

[1] M3x6 screw (4 included in the scope of delivery)

Note

The mounting clip SAMH-PE-MC-8 can be shortened by the user to the required number of slots.

Dimensions and ordering data

B1	B2	B3	D1 ∅	H1	L1	L2	L3	L4	Part no.	Type
17.5	4	5.3	3.2	5	80	70	10	5	571490	SAMH-PE-MC-8

Ordering data – Plugs

	Electrical connection	Part no.	Type
	Plug M8x1, 3-pin, straight, insulation displacement connector	564945	NECU-S-M8G3-HX-Q3
	Straight plug, 4-pin, straight, screw terminal	192008	SEA-4GS-7-2.5