

## Compact cylinder DPDM, multimount

**FESTO**



## Key features

### At a glance

- Double- and single-acting versions
- With and without protection against rotation
- Easy to interchange compared to the compact cylinder DMM
- Simple to mount thanks to a range of mounting interfaces
- Optional: heat-resistant up to 120 °C

### Comparison of compact cylinder DMM and compact cylinder DPDM

- All mounting interfaces of the compact cylinder DPDM are compatible with those of the compact cylinder DMM
- Compared to the DMM, however, the DPDM is noticeably shorter, giving a lower product weight for the same functionality

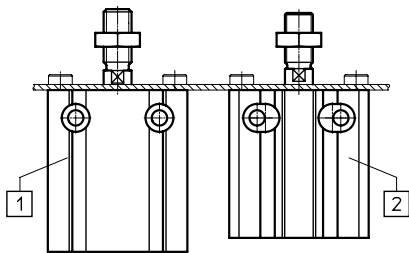

- [1] Compact cylinder DMM  
[2] Compact cylinder DPDM

### Mounting options

#### Mounting at the front

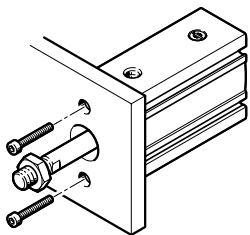

#### Mounting at the rear

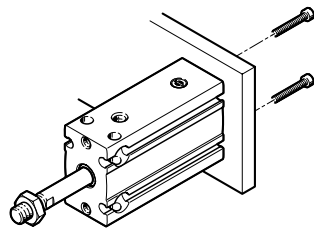

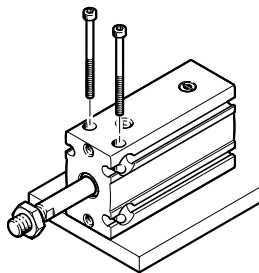

#### Vertical mounting

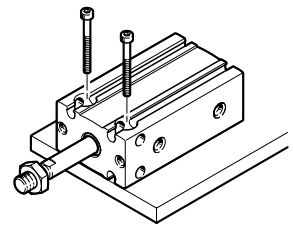

#### Horizontal mounting

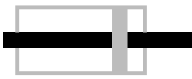
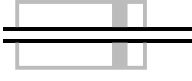

## Key features





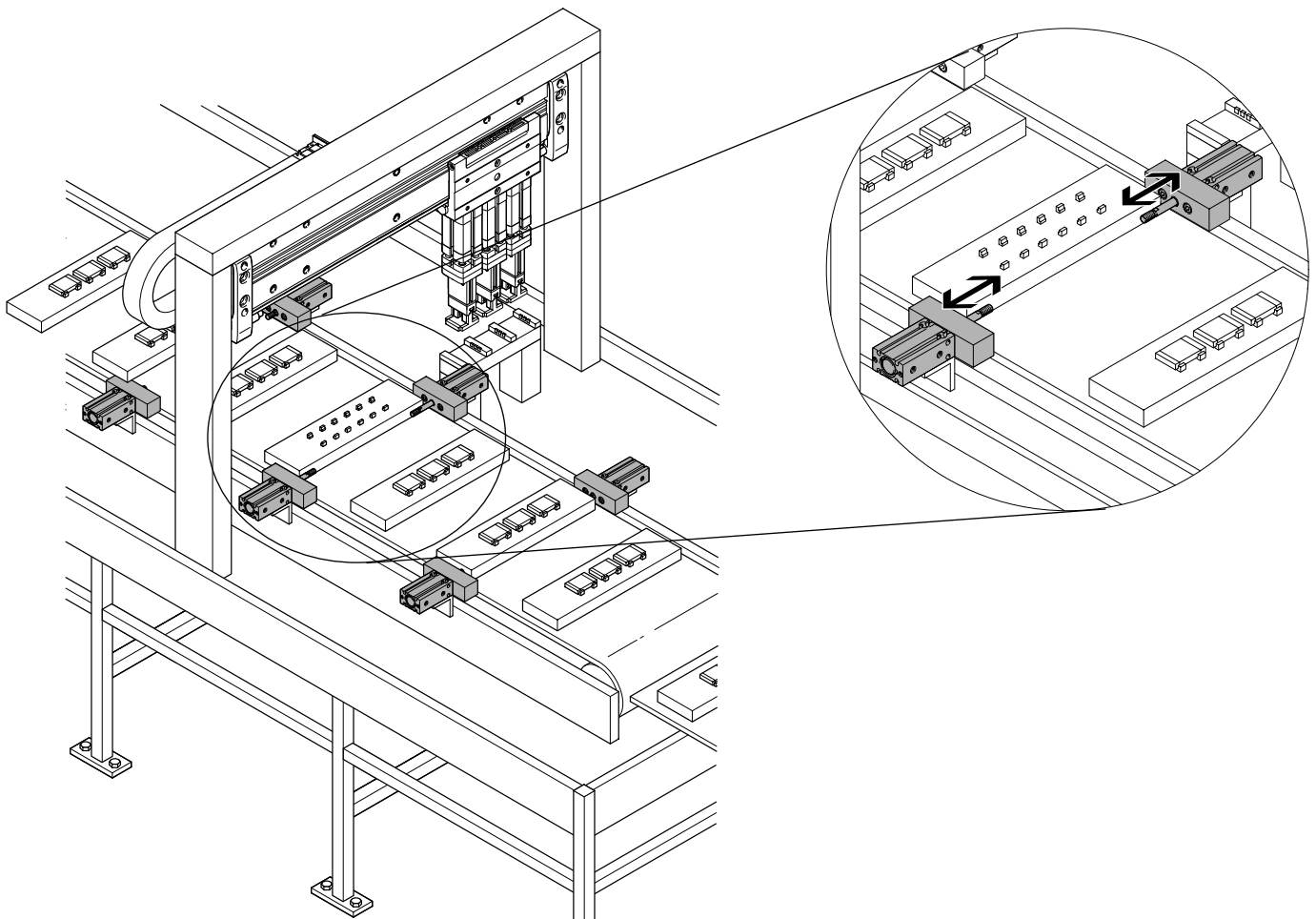

Variants from the modular product system		
Symbol	Key features	Manual
	T Through piston rod	The piston rod can be used for connection at both ends of the cylinder
	H Through, hollow piston rod	The piston rod can be used for connection at both ends of the cylinder. The piston rod is hollow inside. This means it can be used to carry vacuum or compressed air
	T1 Heat-resistant seals	Temperature range 0 ... +120 °C

## Application example

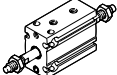
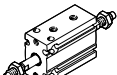
Stopping small parts

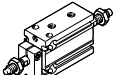
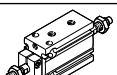

Product range overview

Function	Version	Type	Piston diameter [mm]	Stroke [mm]	Temperature range 0 ... +120 °C	→ Page/ Internet	
Double-acting	<b>Basic type</b>						
		<b>DPDM</b> Piston rod at one end	6, 10 16, 20, 25, 32	5, 10, 15, 20, 25, 30 5, 10, 15, 20, 25, 30, 40, 50	■ From diameter 10	5	
		<b>DPDM-...-T</b> Through piston rod	6, 10 16, 20, 25, 32	5, 10, 15, 20, 25, 30 5, 10, 15, 20, 25, 30, 40, 50	–		
		<b>DPDM-...-H</b> Through, hollow piston rod	16, 20, 25, 32	5, 10, 15, 20, 25, 30, 40, 50	–		
	<b>With protection against rotation</b>						
		<b>DPDM-Q</b> Piston rod at one end	6, 10 16, 20, 25, 32	5, 10, 15, 20, 25, 30 5, 10, 15, 20, 25, 30, 40, 50	■ From diameter 10	5	
		<b>DPDM-Q-...-T</b> Through piston rod	6, 10 16, 20, 25, 32	5, 10, 15, 20, 25, 30 5, 10, 15, 20, 25, 30, 40, 50	–		
		<b>DPDM-Q-...-H</b> Through, hollow piston rod	16, 20, 25, 32	5, 10, 15, 20, 25, 30, 40, 50	–		
	Single-acting	<b>Basic type</b>					
			<b>DPDM-...-S</b> Piston rod at one end, pushing	6, 10, 16, 20, 25, 32	5, 10, 15	–	5
		<b>DPDM-...-P</b> Piston rod at one end, pulling	6, 10, 16, 20, 25, 32	5, 10, 15	–		
<b>With protection against rotation</b>							
	<b>DPDM-Q-...-S</b> Piston rod at one end, pushing	6, 10, 16, 20, 25, 32	5, 10, 15	–	5		
	<b>DPDM-Q-...-P</b> Piston rod at one end, pulling	6, 10, 16, 20, 25, 32	5, 10, 15	–			

## Type codes

001	Series
DPDM	Cylinder, multimount
002	Protection against rotation
	None
Q	With protection against rotation
003	Piston diameter
6	6
10	10
16	16
20	20
25	25
32	32
004	Stroke
5	5
10	10
15	15
20	20
25	25
30	30
40	40
50	50

005	Function
	Double-acting
S	Single-acting, pushing
P	Single-acting, pulling
006	Piston rod type
	At one end
T	Through piston rod
H	Through, hollow piston rod
007	Cushioning
P	Elastic cushioning rings/plates on both sides
008	Position sensing
A	For proximity sensor
009	Temperature range
	Standard
T1	Heat-resistant seals max. 120°C

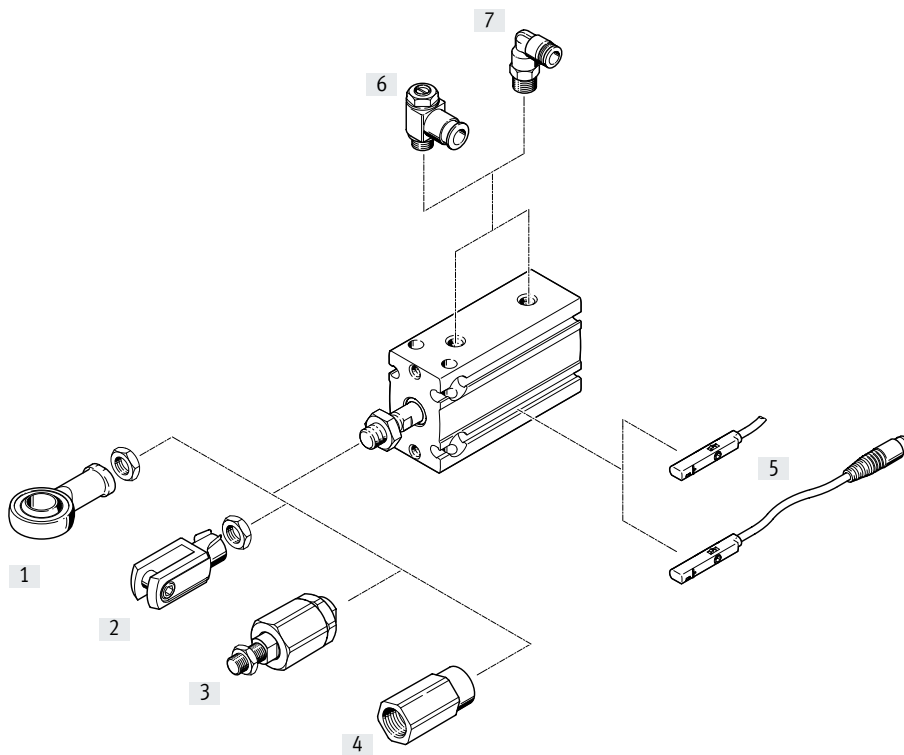

Peripherals overview



Accessories		Manual	→ Page/Internet
[1]	Rod eye SGS	With spherical bearing	16
[2]	Rod clevis SG	Permits a swivelling movement of the cylinder in one plane	16
[3]	Self-aligning rod coupler FK	For compensating radial and angular deviations	16
[4]	Adapter AD	For suction cups with connection	16
[5]	Proximity switch SME/SMT-8, SMT-10	Can be integrated in the cylinder profile barrel	17
[6]	One-way flow control valve GRLA/VFOH	For speed regulation	10
[7]	Push-in fitting QS	For connecting tubing with standard outside diameters	16

## Data sheet

Function  
DPDM

-  - Diameter  
6 ... 32 mm
-  - Stroke length  
5 ... 50 mm

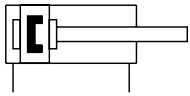

DPDM-...-P

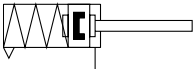

DPDM-...-S

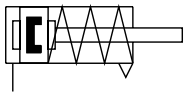

## General technical data

Piston diameter	6	10	16	20	25	32
Design	Piston					
	Piston rod					
	Profile barrel					
Mode of operation	Double- and single-acting					
Pneumatic connection	M5	M5	M5	M5	M5	G1/8
Piston rod thread	M3	M4	M6	M8	M10x1.25	M10x1.25
Stroke	DPDM-... 5, 10, 15, 20, 25, 30					
	DPDM-...S/-P 5, 10, 15					
Cushioning <sup>1)</sup>	Elastic cushioning rings/plates at both ends					
Position sensing	Via proximity switch					
Type of mounting	With through-hole					
	Via female thread					
Mounting position	Optional					

1) With piston diameter 6 in combination with the function "Single-acting, pushing", there is only cushioning at the bearing cap.

## Operating and environmental conditions

Piston diameter	6	10	16	20	25	32
Operating pressure	DPDM-... [MPa] 0.18 ... 0.8					
	[bar] 1.8 ... 8					
	DPDM-Q-... [MPa] 0.2 ... 0.8					
	[bar] 2 ... 8					
	DPDM-...S/-P [MPa] 0.25 ... 0.8					
	[bar] 2.5 ... 8					
Operating medium	Compressed air to ISO 8573-1:2010 [7:4:4]					
Note on the operating/pilot medium	Lubricated operation possible (in which case lubricated operation will always be required)					
Ambient temperature <sup>1)</sup>	DPDM-... [°C] -10 ... +80					
	DPDM-...T1 [°C] - 0 ... +120					
Corrosion resistance CRC <sup>2)</sup>	1					

1) Note operating range of proximity switches.

2) Corrosion resistance class CRC 1 to Festo standard FN 940070

Low corrosion stress. Dry internal application or transport and storage protection. Also applies to parts behind covers, in the non-visible interior area, and parts which are covered in the application (e.g. drive trunnions).

## Data sheet

Forces [N] and impact energy [J]						
Piston diameter	6	10	16	20	25	32
Theoretical force at 0.6 MPa (6 bar, 87 psi), advancing						
DPDM-...	17	47	121	188	295	483
DPDM-...-S	13	38	100	160	269	445
DPDM-...-T/-H	13	40	104	158	247	415
Theoretical force at 0.6 MPa (6 bar, 87 psi), retracting						
DPDM-...	13	40	104	158	247	415
DPDM-...-P	9	31	93	130	221	377
Max. impact energy in the end positions	0.006	0.012	0.15	0.2	0.3	0.4

### Theoretical spring force F as a function of stroke length l

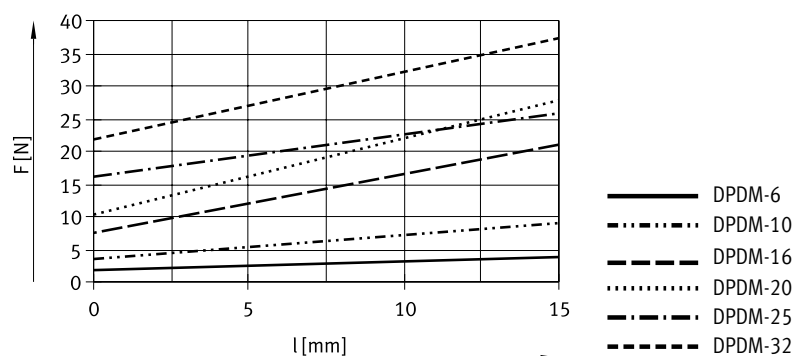

### Max. lateral force F as a function of stroke length l

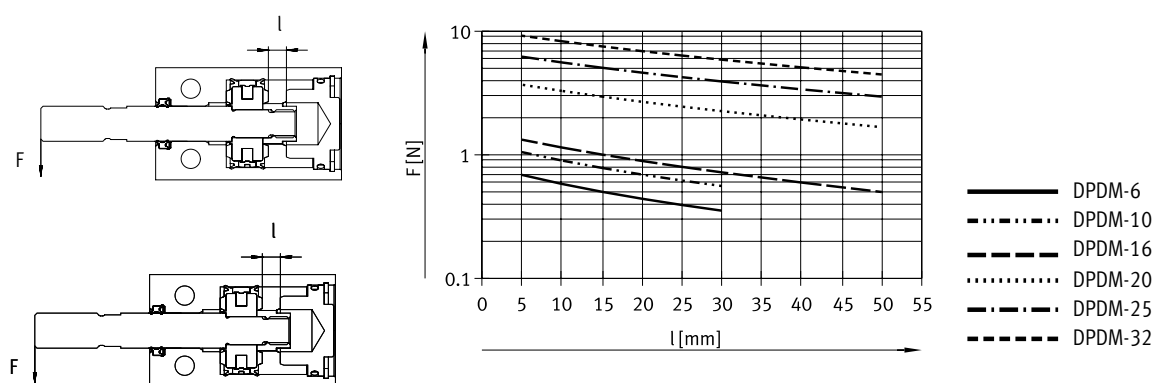

### Technical data – Protection against rotation

Piston diameter	6	10	16	20	25	32
Max. torque at the piston rod <sup>1)</sup> [Nm]	0.0015	0.005	0.01	0.01	0.015	0.02

1) The max. torque must not be exceeded at the piston rod even when fitting attachments

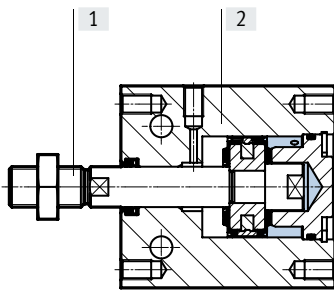

## Data sheet

**Materials****Sectional view**

Compact cylinder

[1] Housing Wrought aluminium alloy

[2] Piston rod High-alloy stainless steel

Seals

DPDM-... NBR/TPE-U(PU)

DPDM-...-T1 HNBR/FKM

- Note on materials RoHS-compliant

**Weights [g]**

Piston diameter	6	10	16	20	25	32
<b>Double-acting</b>						
<b>DPDM-...-PA</b>						
Product weight with 0 mm stroke	20.7	30	66	128	205	307
Additional weight per 10 mm stroke	6.3	7.5	13	22	33.5	51
Moving mass with 0 mm stroke	2.8	6.3	18	34.5	58	85
Moving mass per 10 mm stroke	0.6	1.0	2.3	4	6.5	9
<b>DPDM-Q-...-PA – with protection against rotation</b>						
Product weight with 0 mm stroke	25.5	36.5	75	140	223	331
Additional weight per 10 mm stroke	6.3	7.5	13.5	22.5	35	52.5
Moving mass with 0 mm stroke	7.1	12.5	27	46	76	109
Moving mass per 10 mm stroke	0.9	1.3	2.8	4.6	8	10.5
<b>Single-acting</b>						
<b>DPDM-...-S-PA – pushing</b>						
Product weight with 0 mm stroke	21	30.5	66	117	192	310
Additional weight per 10 mm stroke	6.3	7.5	13	22	33.5	51
Moving mass with 0 mm stroke	3	6.8	18	34.5	58	85
Moving mass per 10 mm stroke	0.6	1	2.3	4	6.5	9
<b>DPDM-Q-...-S-PA – pushing, with protection against rotation</b>						
Product weight with 0 mm stroke	25.5	37	75	129	210	334
Additional weight per 10 mm stroke	6.3	7.5	13	22	35	52.5
Moving mass with 0 mm stroke	7.5	13	27	46	76	109
Moving mass per 10 mm stroke	0.9	1.3	2.8	4.6	8	10.5
<b>DPDM-...-P-PA – pulling</b>						
Product weight with 0 mm stroke	21	30	66	128	208	310
Additional weight per 10 mm stroke	6.3	7.5	13	22	33.5	51
Moving mass with 0 mm stroke	3	7	18	34.5	58	85
Moving mass per 10 mm stroke	0.6	1	2.3	4	6.5	9
<b>DPDM-Q-...-P-PA – pulling, with protection against rotation</b>						
Product weight with 0 mm stroke	25.5	36.5	75	140	226	334
Additional weight per 10 mm stroke	6.3	7.5	13	22	35	52.5
Moving mass with 0 mm stroke	7.5	13.5	27	46	76	109
Moving mass per 10 mm stroke	0.9	1.3	2.8	4.6	8	10.5

Data sheet

Dimensions

Download CAD data → [www.festo.com](http://www.festo.com)

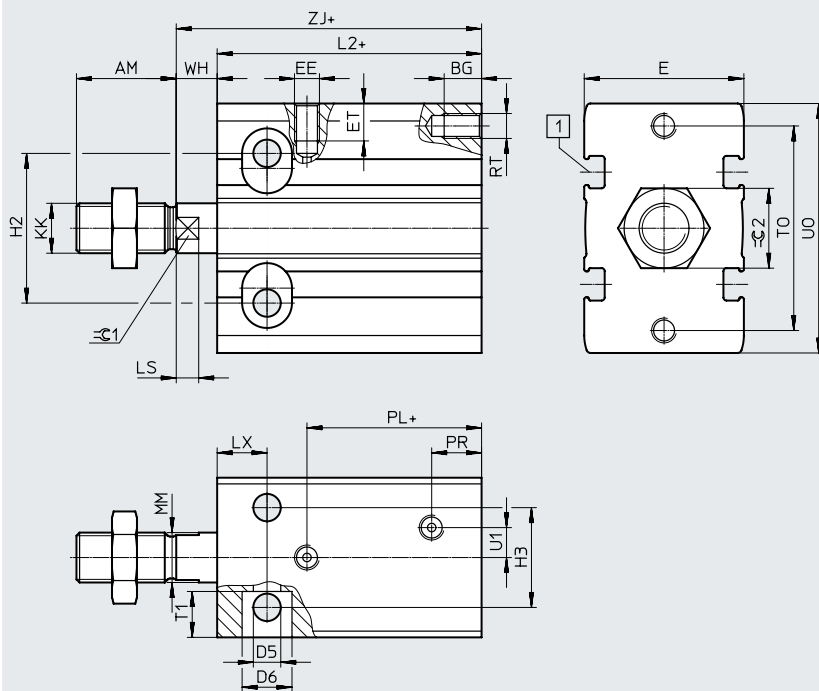

[1] Sensor slot for proximity switch:  
 ø 6 ... 20: SMT-10  
 ø 25/32: SMT/SME-8

ø	AM	BG	D5 ø	D6	E	EE	ET	H2
[mm]					+0.3			
6	7	5	3.2	6	13	M5	4	10
10	10	5	3.2	6	15	M5	4.5	13
16	12	6	4.3	7.5	20	M5	4.5	19
20	16	7.5	5.5	10	26	M5	6	24
25	20	7.5	5.5	10	32	M5	7.5	30
32	20	9	6.6	11	40	G1/8	8.5	40

ø	H3	KK	L2	LS	LX	MM ø	PL	PR
[mm]				-0.1				
6	7	M3	33	-	7	3	17.5	9.5
10	9	M4	35	-	7	4	19.5	9.5
16	13	M6	40	3	7	6	24.1	11
20	16	M8	46	4	9	8	26.5	11
25	20	M10x1.25	48	4.5	10	10	30	10
32	24	M10x1.25	48	4.5	11	12	27	11

ø	RT	T1	T0	U1	U0	WH <sup>1)</sup>	ZJ	≈C1	≈C2
[mm]								h13	
6	M3	5	17	-	22	2	35	-	5.5
10	M3	5	19	-	24	2	37	-	7
16	M4	6	27	-	32	5	45	5	10
20	M5	8.2	33	6	40	6	52	7	13
25	M5	9.2	41	6	50	7	55	9	17
32	M6	12	52	9	62	8	56	10	17

1) WH is measured when the piston rod is in the end position

Data sheet

Dimensions – Variants

Download CAD data → [www.festo.com](http://www.festo.com)

Q – With protection against rotation

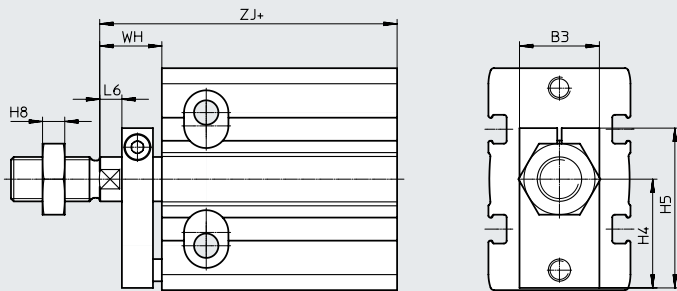

+ = plus stroke length

∅ [mm]	B3	H4	H5	H8	L6	WH	ZJ
6	11	10.5	17.5	1.8	–	9	42
10	14	11.5	19.5	2.2	–	9	44
16	15	15.5	24	3.2	3	12	52
20	15	19.5	29	4	4	13	59
25	18	24.5	36	5	5	14	62
32	20	30.5	45	5	6	15	63

T – Through piston rod  
DPDM- ... -T

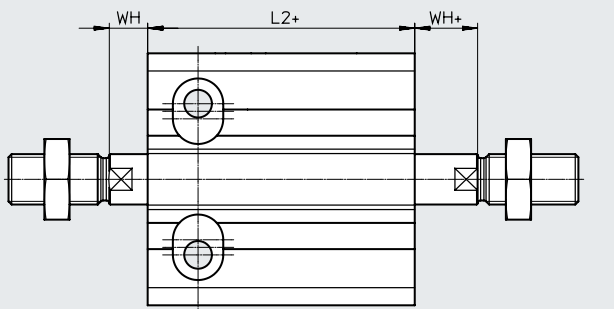

++ = plus 2x stroke length

∅ [mm]	L2	WH	WH+
6	33	2	2
10	35	2	2
16	40	5	5
20	46	6	6
25	48	7	7
32	48	8	8

DPDM-Q- ... -T

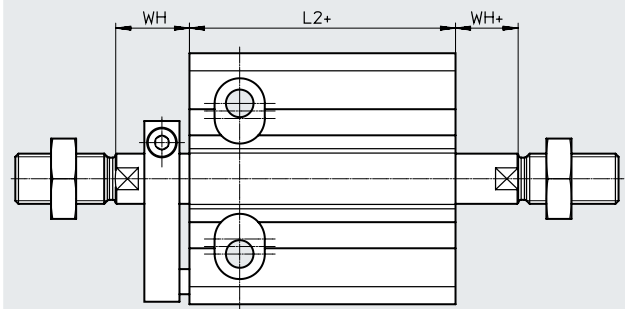

++ = plus 2x stroke length

∅ [mm]	L2	WH	WH+
6	33	9	2
10	35	9	2
16	40	12	5
20	46	13	6
25	48	14	7
32	48	15	8

Data sheet

Dimensions – Variants

Download CAD data → [www.festo.com](http://www.festo.com)

H – Through, hollow piston rod  
 DPDM- ... -H

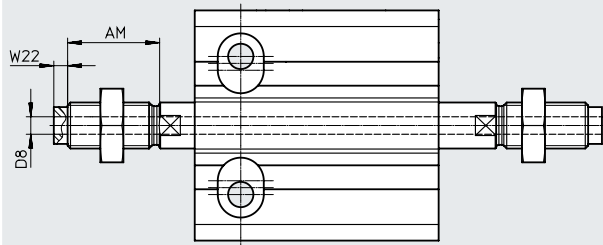

DPDM-Q- ... -H

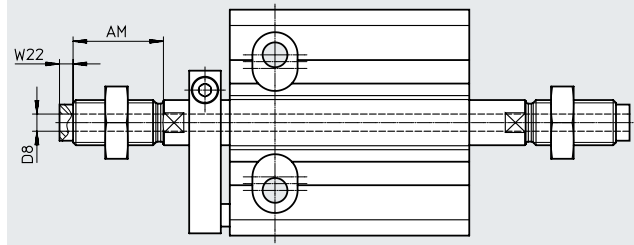

++

= plus 2x stroke length

$\varnothing$ [mm]	AM	D8 $\varnothing$	W22
16	12	2.3	3
20	16	3.2	2
25	20	3.8	3
32	20	4.5	3

## Data sheet

Ordering data – Double-acting						
Type	Piston diameter [mm]	Stroke [mm]	Without protection against rotation		With protection against rotation	
			Part no.	Type	Part no.	Type
	6	5	4830900	DPDM-6-5-PA	4830961	DPDM-Q-6-5-PA
		10	4830901	DPDM-6-10-PA	4830962	DPDM-Q-6-10-PA
		15	4830902	DPDM-6-15-PA	4830963	DPDM-Q-6-15-PA
		20	4830903	DPDM-6-20-PA	4830964	DPDM-Q-6-20-PA
		25	4830904	DPDM-6-25-PA	4830965	DPDM-Q-6-25-PA
		30	4830905	DPDM-6-30-PA	4830966	DPDM-Q-6-30-PA
	10	5	4831868	DPDM-10-5-PA	4832286	DPDM-Q-10-5-PA
		10	4831869	DPDM-10-10-PA	4832288	DPDM-Q-10-10-PA
		15	4831870	DPDM-10-15-PA	4832290	DPDM-Q-10-15-PA
		20	4831872	DPDM-10-20-PA	4832292	DPDM-Q-10-20-PA
		25	4831873	DPDM-10-25-PA	4832294	DPDM-Q-10-25-PA
		30	4831874	DPDM-10-30-PA	4832296	DPDM-Q-10-30-PA
	16	5	4833185	DPDM-16-5-PA	4834260	DPDM-Q-16-5-PA
		10	4833186	DPDM-16-10-PA	4834261	DPDM-Q-16-10-PA
		15	4833187	DPDM-16-15-PA	4834262	DPDM-Q-16-15-PA
		20	4833188	DPDM-16-20-PA	4834263	DPDM-Q-16-20-PA
		25	4833189	DPDM-16-25-PA	4834264	DPDM-Q-16-25-PA
		30	4833190	DPDM-16-30-PA	4834265	DPDM-Q-16-30-PA
		40	4833191	DPDM-16-40-PA	4834266	DPDM-Q-16-40-PA
		40	4833192	DPDM-16-50-PA	4834267	DPDM-Q-16-50-PA
	20	5	4840799	DPDM-20-5-PA	4840813	DPDM-Q-20-5-PA
10		4840800	DPDM-20-10-PA	4840814	DPDM-Q-20-10-PA	
15		4840801	DPDM-20-15-PA	4840815	DPDM-Q-20-15-PA	
20		4840802	DPDM-20-20-PA	4840816	DPDM-Q-20-20-PA	
25		4840803	DPDM-20-25-PA	4840817	DPDM-Q-20-25-PA	
30		4840804	DPDM-20-30-PA	4840818	DPDM-Q-20-30-PA	
40		4840805	DPDM-20-40-PA	4840819	DPDM-Q-20-40-PA	
50		4840806	DPDM-20-50-PA	4840820	DPDM-Q-20-50-PA	
25	5	4829570	DPDM-25-5-PA	4840824	DPDM-Q-25-5-PA	
	10	4829571	DPDM-25-10-PA	4840825	DPDM-Q-25-10-PA	
	15	4829572	DPDM-25-15-PA	4840826	DPDM-Q-25-15-PA	
	20	4829573	DPDM-25-20-PA	4840827	DPDM-Q-25-20-PA	
	25	4829574	DPDM-25-25-PA	4840828	DPDM-Q-25-25-PA	
	30	4829575	DPDM-25-30-PA	4840829	DPDM-Q-25-30-PA	
	40	4829576	DPDM-25-40-PA	4840830	DPDM-Q-25-40-PA	
	50	4829577	DPDM-25-50-PA	4840831	DPDM-Q-25-50-PA	
32	5	4828435	DPDM-32-5-PA	4828465	DPDM-Q-32-5-PA	
	10	4828436	DPDM-32-10-PA	4828466	DPDM-Q-32-10-PA	
	15	4828437	DPDM-32-15-PA	4828467	DPDM-Q-32-15-PA	
	20	4828438	DPDM-32-20-PA	4828468	DPDM-Q-32-20-PA	
	25	4828439	DPDM-32-25-PA	4828469	DPDM-Q-32-25-PA	
	30	4828440	DPDM-32-30-PA	4828470	DPDM-Q-32-30-PA	
	40	4828441	DPDM-32-40-PA	4828471	DPDM-Q-32-40-PA	
	50	4828442	DPDM-32-50-PA	4828472	DPDM-Q-32-50-PA	

Data sheet

Ordering data – Single-acting – Pushing						
Type	Piston diameter [mm]	Stroke [mm]	Without protection against rotation		With protection against rotation	
			Part no.	Type	Part no.	Type
	6	5	4830909	DPDM-6-5-S-PA	4830970	DPDM-Q-6-5-S-PA
		10	4830910	DPDM-6-10-S-PA	4830971	DPDM-Q-6-10-S-PA
		15	4830911	DPDM-6-15-S-PA	4830972	DPDM-Q-6-15-S-PA
	10	5	4832116	DPDM-10-5-S-PA	4833119	DPDM-Q-10-5-S-PA
		10	4832117	DPDM-10-10-S-PA	4833120	DPDM-Q-10-10-S-PA
		15	4832118	DPDM-10-15-S-PA	4833121	DPDM-Q-10-15-S-PA
	16	5	4833272	DPDM-16-5-S-PA	4834367	DPDM-Q-16-5-S-PA
		10	4833273	DPDM-16-10-S-PA	4834368	DPDM-Q-16-10-S-PA
		15	4833274	DPDM-16-15-S-PA	4834369	DPDM-Q-16-15-S-PA
	20	5	4840807	DPDM-20-5-S-PA	4840821	DPDM-Q-20-5-S-PA
		10	4840808	DPDM-20-10-S-PA	4840822	DPDM-Q-20-10-S-PA
		15	4840809	DPDM-20-15-S-PA	4840823	DPDM-Q-20-15-S-PA
	25	5	4829799	DPDM-25-5-S-PA	4840835	DPDM-Q-25-5-S-PA
		10	4829800	DPDM-25-10-S-PA	4840836	DPDM-Q-25-10-S-PA
		15	4829801	DPDM-25-15-S-PA	4840837	DPDM-Q-25-15-S-PA
	32	5	4828428	DPDM-32-5-S-PA	4828490	DPDM-Q-32-5-S-PA
		10	4828429	DPDM-32-10-S-PA	4828491	DPDM-Q-32-10-S-PA
		15	4828430	DPDM-32-15-S-PA	4828492	DPDM-Q-32-15-S-PA

Ordering data – Single-acting – Pulling						
Type	Piston diameter [mm]	Stroke [mm]	Without protection against rotation		With protection against rotation	
			Part no.	Type	Part no.	Type
	6	5	4830946	DPDM-6-5-P-PA	4830974	DPDM-Q-6-5-P-PA
		10	4830947	DPDM-6-10-P-PA	4830975	DPDM-Q-6-10-P-PA
		15	4830948	DPDM-6-15-P-PA	4830976	DPDM-Q-6-15-P-PA
	10	5	4832170	DPDM-10-5-P-PA	4833140	DPDM-Q-10-5-P-PA
		10	4832171	DPDM-10-10-P-PA	4833141	DPDM-Q-10-10-P-PA
		15	4832172	DPDM-10-15-P-PA	4833142	DPDM-Q-10-15-P-PA
	16	5	4833321	DPDM-16-5-P-PA	4834380	DPDM-Q-16-5-P-PA
		10	4833322	DPDM-16-10-P-PA	4834381	DPDM-Q-16-10-P-PA
		15	4833323	DPDM-16-15-P-PA	4834382	DPDM-Q-16-15-P-PA
	20	5	4840810	DPDM-20-5-P-PA	4840832	DPDM-Q-20-5-P-PA
		10	4840811	DPDM-20-10-P-PA	4840833	DPDM-Q-20-10-P-PA
		15	4840812	DPDM-20-15-P-PA	4840834	DPDM-Q-20-15-P-PA
	25	5	4829866	DPDM-25-5-P-PA	4840838	DPDM-Q-25-5-P-PA
		10	4829867	DPDM-25-10-P-PA	4840839	DPDM-Q-25-10-P-PA
		15	4829868	DPDM-25-15-P-PA	4840840	DPDM-Q-25-15-P-PA
	32	5	4829129	DPDM-32-5-P-PA	4828499	DPDM-Q-32-5-P-PA
		10	4829130	DPDM-32-10-P-PA	4828500	DPDM-Q-32-10-P-PA
		15	4829131	DPDM-32-15-P-PA	4828501	DPDM-Q-32-15-P-PA

## Ordering data – Modular product system





Ordering data	6	10	16	20	25	32	Conditions	Code	Enter code	
Module no.	<b>4674228</b>	<b>4693549</b>	<b>4186566</b>	<b>4654766</b>	<b>4328892</b>	<b>4650681</b>				
Function	Compact cylinder								<b>DPDM</b>	DPDM
Protection against rotation	None									
	With protection against rotation								<b>-Q</b>	
Piston diameter [mm]	6	10	16	20	25	32		-...		
Stroke [mm]	5, 10, 15, 20, 25, 30	5, 10, 15, 20, 25, 30	5, 10, 15, 20, 25, 30, 40, 50	5, 10, 15, 20, 25, 30, 40, 50	5, 10, 15, 20, 25, 30, 40, 50	5, 10, 15, 20, 25, 30, 40, 50		-...		
Function	Double-acting									
	Single-acting, pulling							[1]	<b>-P</b>	
	Single-acting, pushing							[1]	<b>-S</b>	
Piston rod type	At one end									
	-		Through, hollow piston rod					[2]	<b>H</b>	
	Through piston rod							[2]	<b>T</b>	
Cushioning	Elastic cushioning rings/plates at both ends								<b>-P</b>	-P
Position sensing	Via proximity switch								<b>A</b>	A
Temperature range	Standard									
	-		Heat-resistant seals max. 120 °C					[2] [3]	<b>-T1</b>	

[1] P, S Only with stroke 5, 10, 15 mm





[2] H, T, T1 Not with P/S

[3] T1 Not with H, T

Accessories

Ordering data – Piston rod attachments				Data sheets → Internet: piston rod attachment			
Designation	For diameter	Part no.	Type	Designation	For diameter	Part no.	Type
<b>Rod eye SGS</b>				<b>Self-aligning rod coupler FK</b>			
	10	9253	SGS-M4		10	6528	FK-M4
	16	9254	SGS-M6		16	2061	FK-M6
	20	9255	SGS-M8		20	2062	FK-M8
	25	9261	SGS-M10x1.25		25	6140	FK-M10x1.25
	32				32		
<b>Rod clevis SG</b>				<b>Adapter AD</b>			
	10	6532	SG-M4		10	-	-
	16	3110	SG-M6		16	157328	AD-M6-M5
	20	3111	SG-M8		16	157329	AD-M6-1/8
	25	6144	SG-M10x1.25		20	157331	AD-M8-1/8
	32	6144	SG-M10x1.25		20	157332	AD-M8-1/4
				25	157333	AD-M10x1.25-1/8	
				25	157334	AD-M10x1.25-1/4	
				32	157333	AD-M10x1.25-1/8	
				32	157334	AD-M10x1.25-1/4	

Ordering data – One-way flow control valves					Data sheets → Internet: grl	
For diameter	Connection		For tubing O.D.	Weight [g]	Part no.	Type
	Thread					
<b>For exhaust air</b>						
	6, 10, 16, 20, 25	M5	4	13	193138	GRLA-M5-QS-4-D
			6	13	193139	GRLA-M5-QS-6-D
			4	14	197577	GRLA-M5-QS-4-RS-D
			6	14	197578	GRLA-M5-QS-6-RS-D
			32	G1/8	3	22
4	22	193145	GRLA-1/8-QS-8-D			
6	23	197581	GRLA-1/8-QS-6-RS-D			
8	24	534337	GRLA-1/8-QS-8-RS-D			

Ordering data – Push-in fittings						PE <sup>1)</sup>
For diameter	Connection		For tubing O.D.	Weight [g]	Part no.	
	Thread					
<b>Standard</b>						
	6, 10, 16, 20, 25	M5	3	3.4	153302	QSM-M5-3
			4	3.2	153304	QSM-M5-4
			6	4.5	153306	QSM-M5-6
	6, 10, 16, 20, 25	M5	4	3.4	153333	QSML-M5-4
			6	4.1	153335	QSML-M5-6
	32	G1/8	6	8.2	153002	QS-1/8-6
			8	14	153004	QS-1/8-8
	32	G1/8	6	11	153046	QSL-1/8-6
			8	14	153048	QSL-1/8-8







## Accessories

## Proximity switches for piston diameter 6 ... 20

Ordering data – Proximity switches for C-slot, magneto-resistive						Data sheets → Internet: smt
	Type of mounting	Switching output	Electrical connection	Cable length [m]	Part no.	Type
<b>N/O contact</b>						
	Inserted in the slot from above, flush with the cylinder profile, short design	PNP	Cable, 3-wire	2.5 m	551373	SMT-10M-PS-24V-E-2,5-L-OE
		PNP	Plug M8x1, 3-pin	0.3 m	551375	SMT-10M-PS-24V-E-0,3-L-M8D
		NPN	Cable, 3-wire	2.5 m	551377	SMT-10M-NS-24V-E-2,5-L-OE
		NPN	Plug M8x1, 3-pin	0.3 m	551379	SMT-10M-NS-24V-E-0,3-L-M8D

## Proximity switches for piston diameter 25/32

Ordering data – Proximity switches for T-slot, magneto-resistive						Data sheets → Internet: smt
	Type of mounting	Switching output	Electrical connection	Cable length [m]	Part no.	Type
<b>N/O contact</b>						
	Inserted in the slot from above, flush with the cylinder profile, short design	PNP	Cable, 3-wire	2.5	574335	SMT-8M-A-PS-24V-E-2,5-OE
			Plug M8x1, 3-pin	0.3	574334	SMT-8M-A-PS-24V-E-0,3-M8D
		NPN	Cable, 3-wire	2.5	574338	SMT-8M-A-NS-24V-E-2,5-OE
			Plug M8x1, 3-pin	0.3	574339	SMT-8M-A-NS-24V-E-0,3-M8D
<b>N/C contact</b>						
	Inserted in the slot from above, flush with the cylinder profile, short design	PNP	Cable, 3-wire	7.5	574340	SMT-8M-A-PO-24V-E-7,5-OE

Ordering data – Connecting cables					Data sheets → Internet: nebu
	Electrical connection, left	Electrical connection, right	Cable length [m]	Part no.	Type
	Straight socket, M8x1, 3-pin	Cable, open end, 3-wire	2.5	541333	NEBU-M8G3-K-2.5-LE3
			5	541334	NEBU-M8G3-K-5-LE3
	Angled socket, M8x1, 3-pin	Cable, open end, 3-wire	2.5	541338	NEBU-M8W3-K-2.5-LE3
			5	541341	NEBU-M8W3-K-5-LE3

Accessories

For variant DPDM-...T1, temperature range 0 ... +120 °C





Ordering data – One-way flow control valves

Data sheets → Internet: vfoh

	For diameter	Connection		Weight [g]	Part no.	Type
		Thread	For tubing O.D.			
	32	G1/8	4	23	578797	VFOH-LE-A-G18-Q4
			6	23	578798	VFOH-LE-A-G18-Q6

Ordering data – Push-in fittings

Data sheets → Internet: crqs

	For diameter	Connection		Weight [g]	Part no.	Type
		Thread	For tubing O.D.			
<b>Stainless steel</b>						
	6, 10, 16, 20, 25	M5	4	6.0	162860	CRQS-M5-4 <sup>1)</sup>
			6	8.4	162861	CRQS-M5-6 <sup>1)</sup>
	6, 10, 16, 20, 25	M5	4	12	162870	CRQSL-M5-4 <sup>1)</sup>
			6	18	162871	CRQSL-M5-6 <sup>1)</sup>
	32	R1/8	6	9.9	162862	CRQS-1/8-6
			8	12	162863	CRQS-1/8-8
	32	R1/8	6	19	162872	CRQSL-1/8-6
			8	26	162873	CRQSL-1/8-8

1) With sealing ring

Ordering data – Proximity switches for T-slot, magnetic reed

Data sheets → Internet: sme

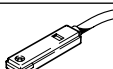
	Type of mounting	Switching output	Electrical connection	Cable length [m]	Part no.	Type
	Heat-resistant up to 120 °C	Contacting, bipolar	Cable, 2-wire	2.5	161756	SME-8-K-24-S6